



# Acquisition Directorate

---

## Research & Development Center

# HF Digital Radio Mondiale (DRM) Broadcast Summary Report

**For Long Range Dissemination of Maritime Information**

Distribution Statement A: Approved for public release; distribution is unlimited.

April 2018



# Homeland Security

# NOTICE

This document is disseminated under the sponsorship of the Department of Homeland Security in the interest of information exchange.

For use outside the United States Government, the Government assumes no liability for its contents or use thereof.

The United States Government does not endorse products or manufacturers. Trade or manufacturers' names appear herein solely because they are considered essential to the objective of this report.



Mr. Jim Fletcher  
E&W Branch Chief  
United States Coast Guard  
Research & Development Center  
1 Chelsea Street  
New London, CT 06320



# HF Digital Radio Mondiale (DRM) Broadcast Summary Report

## Technical Report Documentation Page

1. Report No.		2. Government Accession Number		3. Recipient's Catalog No.	
4. Title and Subtitle HF Digital Radio Mondiale (DRM) Broadcast Summary Report For Long Range Dissemination of Maritime Information				5. Report Date April 2018	
				6. Performing Organization Code Project No. 6211	
7. Author(s) USCG Research and Development Center (RDC) - Ms. Irene M. Gonin, LCDR Aaron P. Dahlen, LTJG Hessamoddin Shafeian, and Alion Science & Technology (ALION) - Dr. Gregory W. Johnson and Christopher Grayson				8. Performing Report No. R&DC UDI # 1732	
9. Performing Organization Name and Address Sonalysts, Inc. 215 Parkway North Waterford, CT 06385 Alion Science and Technology 1 Chelsea St., Ste 200 New London, CT 06320		U.S. Coast Guard Research and Development Center 1 Chelsea Street New London, CT 06320		10. Work Unit No. (TRAIS)	
				11. Contract or Grant No. HSCG32-14-D-R00002/HSCG32-16-J-100007	
12. Sponsoring Organization Name and Address US COAST GUARD COMMANDANT (CG-652) STOP 7710 COMMANDANT (CG-NAV) STOP 7418 2703 MARTIN LUTHER KING JR AVE SE WASHINGTON, DC 20593  Commanding Officer (COMMCOM) 4720 Douglas A Munro Rd., Chesapeake, VA 23322				13. Type of Report & Period Covered Final	
				14. Sponsoring Agency Code US Coast Guard Commandant (CG-652) Stop 7710 Commandant (CG-NAV) Stop 7418 Washington, DC 20593	
15. Supplementary Notes The R&D Center's technical point of contact is Ms. Irene Gonin, 860-271-2694, email: Irene.M.Gonin@uscg.mil					
16. Abstract (MAXIMUM 200 WORDS)  Digital Radio Mondiale (DRM) is a broadcasting technology that has the potential to disseminate electronic Maritime Safety Information over a wide geographical area. In this report, the Coast Guard Research and Development Center (RDC) presents a Concept of Operations (CONOPS) describing how a single DRM transmitter can provide coverage for the Arctic. The report outlines the methodology upon which the CONOPS is based including an Arctic field test conducted by the RDC in which user feedback and field test data were collected. The test proves that the HF DRM prototype offers an affordable and reliable alternative to distribute navigation safety information. Since the prototype infrastructure is comprised of the existing Coast Guard assets (e.g. USCG HF Transmitters and HF antennas) and proven Commercial-Off-The-Shelf products (e.g. DRM content server, modulator and receiver), the total cost of the prototype is relatively low. In addition, the report investigates how the coverage may be expanded to the contiguous United States and Hawaii. It concludes with specific recommendations for future work required to transition the technology to a public service to the mariner.					
17. Key Words Digital Radio, Digital Radio Mondiale, DRM, High Frequency, HF, Navigation Safety Information, NSI, NAVTEX, NAVDAT, United States Coast Guard, USCG, Research and Development Center, RDC, Arctic, Communications, Arctic Navigational Safety Information System, ANSIS, Maritime Safety Information, MSI, eMSI			18. Distribution Statement Distribution Statement A: Approved for public release; distribution is unlimited.		
19. Security Class (This Report) UNCLAS//Public		20. Security Class (This Page) UNCLAS//Public		21. No of Pages 112	22. Price



**(This page intentionally left blank.)**



## ACKNOWLEDGEMENT

A special thank you to the many people that contributed their time and effort to support this successful field test in Alaska. If it were not for their dedication and professionalism, this study would not have been possible.

- CG C3CEN: Mr. Paul Miller, LT Andrew Siwarski and ELC2 Brett Edgerly
- CG COMMDDET Kodiak: CDR Douglas Norstrom, CWO Benjamin DiGuilio, Mr. Joseph Kelleher, ET1 Michael Manning and ET2 Shane Thompson
- USCGC SYCAMORE: CDR J. Jarnac, ET1 Ryan Torbett and ET2 Jay Tracy
- CG COMMCOM: CDR Michael Crider and CWO3 Kenneth Sturgill,
- CG Headquarters: Mr. Jorge Arroyo, Mr. Joseph Jersey and Mr. Robert (Brian) Page,
- USCGC HEALY: ETCS Brian Moller
- USCGC MAPLE: ET1 Matthew Ford, LT Lisa Hatland and ENS Megan Toomey
- D17: Mr. David Seris and Mr. Brian Williams
- SFLC: ELC3 Scott Greenlaw
- RDC: Mr. John Maloney, Dr. Anita Rothblum
- ALION Science and Technology: Dr. Gregory Johnson and Mr. Christopher Grayson
- BASE Cape Cod: Mr. William Walsh
- CG Spectrum Management: Mr. Brian Williams, Mr. Terry Holom and Mr. Patrick Perseille
- RFmondial: Dr. Stefan Geller and Jens Schroeder
- Fraunhofer: Bernd Linz
- Ampegon (merged with Transradio): Christian Hoerlle



**(This page intentionally left blank.)**



## EXECUTIVE SUMMARY

Increased Arctic maritime activity has the potential to increase marine accidents and environmental harm to the fragile environment. Improving the mariner's situational awareness through clear, timely communication has been identified as a way to mitigate the hazards. The large Arctic expanse, coupled with the lack of communications infrastructure, present many challenges. The Next Generation Arctic Navigational Safety Information System (ANSIS) is an ongoing United States Coast Guard (USCG) Research and Development Center (RDC) effort, which attempts to find solutions for mitigating the challenges in radio communications for disseminating safety and navigation information to the Arctic mariners.

As part of the ANSIS project, the RDC evaluated Digital Radio Mondiale (DRM). DRM is an open standard that shows promise for modernizing the USCG's radio broadcast capability. DRM is intended to be used to broadcast information related to marine safety and security from shore to ship. DRM provides a data rate throughput that would allow transmission of detailed weather maps, forecast weather, ice edge, ice maps, and notice to mariners information. DRM can be used with any frequency band (e.g., Very High Frequency (VHF), High Frequency (HF), and Medium Frequency (MF)). Of these three frequency bands, HF appeared to be the most feasible to test and implement due to the existing USCG HF infrastructure in Alaska and the large coverage provided by HF. RDC carried out a field test of HF DRM performance.

The Alaska field test transmission setup includes existing USCG HF transmitter and antenna, combined with Commercial-Off-The-Shelf (COTS) DRM equipment: an RFmondial content server which fetches and formats the data and Transradio Modulator which prepares the data for HF transmission. COMMSTA Kodiak, AK, was used as the transmission site. The receive system utilized RFmondial DRM receivers. Two receivers were installed in Cordova, AK, and then, midway through the field test, moved to the USCGC HEALY and USCGC MAPLE.

RDC conducted a year-long field test of the DRM system. The field test demonstrated that the DRM is capable of transmitting maritime and navigation safety information to the Arctic Mariner. Underway vessels were able to receive detailed images such as wave, surface, and wind forecasts as well as ice maps. Text-based messages were received such as traditional Marine Safety Information (MSI) Bulletins, NOAA buoy data, and even the latest news. Automatic Identification System (AIS) Application Specific Messages (ASM), such as the National Ice Center's ice edge, various Alaskan meteorological (met) data, and virtual aids to navigation (ATON), were received as well.

RDC used the field test data to verify the DRM transmission against the International Telecommunication Union's (ITU) HF propagation models. The good fit between experimental and theoretical propagation strongly suggests that the ITU tools may be used to predict the DRM coverage and develop a notional Concept of Operations (CONOPS).

Three options are presented that describe how the USCG may use the DRM system not only in Alaska, but Hawaii, and the contiguous United States. These options are:

- Full Geographic Coverage; recommends high wattage transmitters in ideal locations to provide the best geographic coverage by rotating through the three best frequencies (20 minutes on each frequency per hour); medium cost.



## HF Digital Radio Mondiale (DRM) Broadcast Summary Report

- Full 24-Hour Coverage; recommends using existing USCG HF transmitters to provide 24-hour coverage by transmitting on three separate frequencies simultaneously (simulcast); low cost;
- Full Geographic and 24-Hour Coverage; combines the best of each option above; higher cost.

The highlight of the CONOPS is included below as Figure ES-1. This shows that a single transmitter installed in Fairbanks, Alaska, can provide geographic coverage to the Alaskan Arctic (highlighted in red). It can send hundreds of text messages and a few dozen images in a 20-minute block.

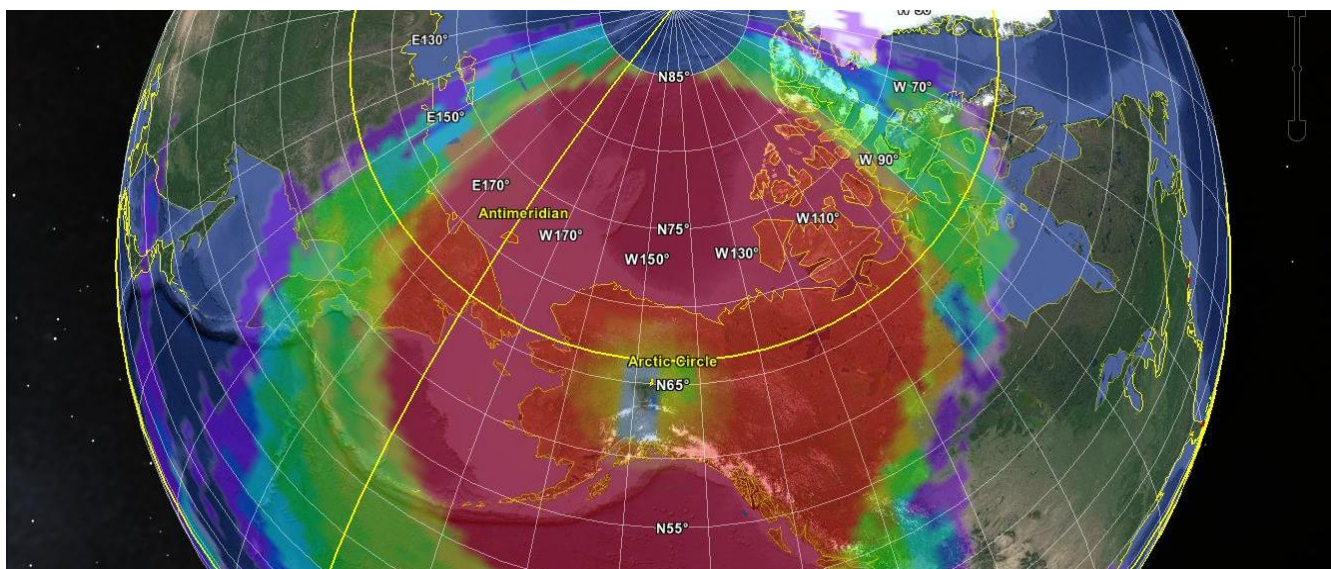

Figure ES-1. August propagation forecast for Fairbanks, AK, DRM transmission.

This report finds DRM to be a good technology for a cost-effective method to disseminate marine and navigation safety information to the mariner. The report concludes with specific recommendations for future work. These include:

- USCG and the U.S. Committee on the Marine Transportation System (CMTS) collaborate to develop a better understanding of the mariner needs for maritime and navigation safety information, in particular the interval and resolution of data.
- USCG collaborate with NOAA to produce products for DRM transmissions ideally suited for the shipboard mariner
- USCG work with the International Maritime Organization (IMO) and the Global Maritime Distress and Safety System (GMDSS) standards to identify suitable DRM equipment and procedures for the dissemination of Marine Safety Information (MSI) to shipboard mariners.
- USCG Communications Command (COMMCOM) implement a pilot DRM service to assist in developing a better understanding of transmitter power, antennas, and locations for use with DRM.
- Evaluate the use of DRM as contingency communications.
- USCG Academy (USCGA) and RDC perform market research to investigate the capabilities and limitations of commercial-off-the-shelf (COTS) DRM receivers.
- RDC Partner with CG-Cyber and CG-791 to research suitable cyber security measures for DRM transmissions.





**(This page intentionally left blank.)**



## TABLE OF CONTENTS

<b>ACKNOWLEDGEMENT</b> .....	<b>v</b>
<b>LIST OF FIGURES</b> .....	<b>xii</b>
<b>LIST OF TABLES</b> .....	<b>xv</b>
<b>LIST OF ACRONYMS, ABBREVIATIONS, AND SYMBOLS</b> .....	<b>xvi</b>
<b>1 INTRODUCTION</b> .....	<b>1</b>
<b>2 DIGITAL RADIO MONDIALE AND JOURNALINE</b> .....	<b>1</b>
2.1 DRM Standard.....	1
2.2 Journaline Standard.....	2
2.3 State of the Market.....	3
<b>3 FIELD TEST EQUIPMENT</b> .....	<b>4</b>
3.1 Data Channels: Fetchers/Formatters.....	4
3.1.1 Information Broadcast.....	6
3.2 Transmitter System.....	8
3.3 Receiver System.....	10
3.4 Display Systems.....	11
3.4.1 Journaline Channel.....	11
3.4.2 AIS Channel.....	12
<b>4 SUMMARY OF METHODS</b> .....	<b>13</b>
<b>5 EVALUATION</b> .....	<b>14</b>
5.1 Equipment Functionality.....	14
5.2 User Feedback.....	14
5.2.1 Analysis of USCGC HEALY Crew and Guests Users.....	14
5.2.2 Analysis of Amateur Radio Users.....	16
<b>6 ANALYSIS of the DRM DATA</b> .....	<b>17</b>
6.1 Propagation and Model Validation.....	17
6.1.1 Kodiak to Cordova Link.....	17
6.1.2 Kodiak to USCGC HEALY and MAPLE.....	20
6.2 Analysis Conclusion.....	29
<b>7 NOTIONAL CONOPS</b> .....	<b>30</b>
7.1 Alaska DRM Forecast.....	31
7.1.1 Alaska Full Geographic Coverage Option.....	31
7.1.2 Alaska Full 24-Hour Coverage Option.....	33
7.1.3 Alaska Full Geographic and 24-Hour Coverage.....	35
7.2 Expanded DRM Coverage.....	35
7.2.1 Full Geographic Coverage Option.....	35
7.2.2 Full 24-Hour Coverage Option.....	36
7.2.3 Full Geographic and 24-Hour Coverage Option.....	38
7.3 System Capability and Cost.....	38
<b>8 RECOMMENDATIONS FOR FUTURE WORK</b> .....	<b>42</b>
<b>9 REFERENCES</b> .....	<b>45</b>



# HF Digital Radio Mondiale (DRM) Broadcast Summary Report

---

**APPENDIX A. CODE OF FEDERAL REGULATIONS ON DRM..... A-1**  
**APPENDIX B. DRM INSTALLATION ..... B-1**  
**APPENDIX C. FIELD TEST DATA SOURCES AND DISPLAY ..... C-1**  
**APPENDIX D. HF PROPAGATION MODEL ..... D-1**  
**APPENDIX E. TRANSMIT ANTENNA PATTERNS..... E-1**  
**APPENDIX F. ARTICLE – AMATEUR RADIO DRM RECEPTION .....F-3**  
**APPENDIX G. ADDITIONAL UNDERWAY DATA..... G-1**  
**APPENDIX H. ADDITIONAL BACKGROUND.....H-1**



## LIST OF FIGURES

Figure ES-1. August propagation forecast for Fairbanks, AK, DRM transmission. ....	viii
Figure 1. Fetcher/Formatters feed the Journaline service. ....	2
Figure 2. The end user reads the USCG Journaline service as if it was a web page. ....	3
Figure 3. Block diagram of the DRM transmit and receive systems. ....	4
Figure 4. The Fetcher/Formatter software automatically builds the USCG DRM Service feed. ....	5
Figure 5. (Left) Kodiak HF transmitter #12 (tall cabinet on end of row closest to viewer) and portable server rack. (Right) Close-up of the portable server rack housing the content server, DMOD3 modulator, and Ethernet switch. ....	8
Figure 6. Kodiak HF DRM Transmit System installation block diagram. ....	9
Figure 7. Alaska field test receive installation (Laptop and DRM Receiver). ....	10
Figure 8. HF DRM receive installation block diagram. ....	11
Figure 9. Journaline’s root level display (left) and representative weather forecast (right). ....	12
Figure 10. Representative AIS-based ice edge as displayed on TV32. ....	13
Figure 11. DRM data displayed on a mobile phone. (Left) Phone display of Weather Map. (Right) Mobile phone display of News. ....	16
Figure 12. Representative signal strength for Cordova reception (December 2016 – 5200 kHz). ....	18
Figure 13. Kodiak DMR 24-hour forecast coverage (Green) for December 2016 at 5,200 kHz. Cordova, AK, is highlighted in Blue. ....	19
Figure 14. USCGC HEALY reception, all frequencies. ....	21
Figure 15. USCGC MAPLE reception, all frequencies. ....	22
Figure 16. Jul 22, 2017 forecast coverage of 6850 kHz (green) with USCGC HEALY (red) and MAPLE (cyan). ....	24
Figure 17. Jul 22, 2017 SNR at 6850 kHz as recorded on USCGC HEALY (data in red) receiving a ground wave (model only accounts for sky wave) and MAPLE (data in cyan). ....	25
Figure 18. Jul 27, 2017 forecast coverage of 8000 kHz (green) with USCGC HEALY (red) and MAPLE (cyan). ....	26
Figure 19. Jul 27, 2017 SNR at 8000 kHz as recorded on USCGC HEALY (red) and MAPLE (cyan). ....	27
Figure 20. Aug 03, 2017, forecast coverage of 5200 kHz (green) with USCGC HEALY (red). ....	28
Figure 21. Aug 03, 2017 SNR at 5200 kHz as recorded on USCGC HEALY. ....	29
Figure 22. August propagation forecast for Fairbanks DRM transmission. ....	33
Figure 23. August propagation forecast for 24-hour Kodiak DRM transmission (existing infrastructure). ..	34
Figure 24. August propagation forecast Full Geographic Coverage Option. ....	36
Figure 25. August propagation forecast for Full 24-hour Coverage Option. ....	37
Figure 26. This 150 kB wind and wave forecast takes 1.7 minutes to transmit. ....	39
Figure 27. This 80 kB wind and wave forecast takes 0.9 minutes (54 seconds) to transmit. ....	40
Figure 28. A 5.2 kB High Seas Forecast (partial shown) takes about 3.7 seconds to transmit. ....	41
Figure B-1. Kodiak installation block diagram. ....	B-1
Figure B-2. (Left) Kodiak HF transmitter #12 (tall cabinet on end) and portable server rack, (Right) close up of the portable server rack housing the content server, DMOD3 modulator, and Ethernet switch. ....	B-2
Figure B-3. Kodiak desktop control computer (on desk). ....	B-2
Figure B-4. Front of Rockwell Collins RT-2200 Exciter (left), rear of RT-2200 showing jumper location (right). ....	B-3



# HF Digital Radio Mondiale (DRM) Broadcast Summary Report

Figure B-5. Transmitter antenna interlock circled in red (left) and installed RF tap circled in orange (right). ..... B-4

Figure B-6. Back of DMOD3 showing RF output and RF input connections..... B-4

Figure B-7. Block diagram of receiver systems..... B-5

Figure B-8. (Left) Monitor receiver, laptop, and Verizon cellular modem on top of cabinet, (Right) Monitor receiver’s directional loop antenna. .... B-6

Figure B-9. Laptop located on chart table onboard SYCAMORE..... B-6

Figure B-10. USCGC SYCAMORE receiver mounted in cabinet rack in bridge chart room. .... B-7

Figure B-11. Antenna (circled in red) mounted to inside of rail on deck above bridge on USCGC SYCAMORE. Close-up of rail mount on right. .... B-8

Figure B-12. Antenna cable run through existing stuffing tube. .... B-9

Figure B-13. DRM receiver installed in USCGC HEALY’s radio room. The antenna on the port side flying bridge was used. .... B-10

Figure B-14. (Left) Receiver and laptop mounted in rack in chart room on USCGC MAPLE. (Right) The HF receive antenna, located on starboard aft corner of bridge wing. .... B-11

Figure C-1. TV32 display of AIS weather buoys. .... C-2

Figure C-2. TV32 display of AIS weather stations..... C-3

Figure C-3. TV32 display of AIS ice edges..... C-4

Figure C-4. Journaline service index. .... C-5

Figure C-5. Example of Journaline MSIB. .... C-5

Figure C-6. Example of Journaline weather station..... C-6

Figure C-7. Example of Journaline “48-hour Wind and Wave Forecast”. .... C-6

Figure C-8. Outline (index) of Journaline Service at end of field testing..... C-7

Figure C-9. Alaska Coastal Waters Forecasts NAVTEX options. .... C-7

Figure C-10. One of the Alaska Coastal Waters Forecasts Selections. .... C-8

Figure C-12. Example of Journaline Marine Weather Forecast options. .... C-9

Figure C-13. Example of Journaline Marine Weather Forecast data..... C-9

Figure C-14. Example of Journaline Weather Map “5-Day Sea Ice Forecast”. .... C-10

Figure C-15. Example of Journaline Weather Map, “Canadian Ice Map”. .... C-10

Figure D-1. Historical sunspot numbers. .... D-2

Figure D-2. 24-hour forecast of a 3.0 MHz signal. An SNR of at least 15 (violet) is required for voice communications..... D-3

Figure D-3. 24 hour forecast of a 13.0 MHz signal..... D-4

Figure D-4. Forecast availability for 3.0 and 13.0 MHz over a 24-hour period. This is a composite image where data from Figure D-3 and Figure D-4 are combined. .... D-5

Figure D-5. Daily forecast of percent constructed by combining data from Figure D-4. Users in the green shaded area can expect a signal availability greater than 90%. .... D-6

Figure E-1. Representative antennas and radiation patterns TCI-530 (middle), TCI-540 (bottom), TCI-550 (top). .... E-1

Figure G-1. Jul 25, 2017 forecast of 5200 kHz (green) with USCGC HEALY (red) and MAPLE (cyan).. G-2

Figure G-2. Jul 25, 2017 SNR as recorded on USCGC HEALY (red) and MAPLE (cyan). .... G-3

Figure G-3. Aug 01, 2017 forecast of 8000 kHz (green) with USCGC HEALY (red). .... G-4

Figure G-4. Aug 01, 2017 SNR as recorded on USCGC HEALY. .... G-5

Figure G-5. Aug 08, 2017 forecast of 8000 kHz (green) with USCGC HEALY (red). .... G-6

Figure G-6. Aug 08, 2017 SNR as recorded on USCGC HEALY. .... G-7



# HF Digital Radio Mondiale (DRM) Broadcast Summary Report

---

Figure G-7. Aug 10, 2017 forecast of 6850 kHz (green) with USCGC HEALY (red). ..... G-8  
Figure G-8. Aug 10, 2017 SNR as recorded on USCGC HEALY. .... G-9  
Figure H-1. Lab test equipment set-up. .... H-2  
Figure H-2. Field test equipment set-up. .... H-3



## LIST OF TABLES

Table 1. DRM File Service Summary.....	6
Table 2. DRM Journaline Service Summary .....	7
Table 3. DRM AIS ASM Service Summary.....	7
Table 4. Model Assumptions for DRM Coverage Options .....	30
Table 5. Proposed Alaska Data Broadcast (for 20 minutes).....	32
Table 6. Potential DRM locations to provide nationwide geographic coverage. ....	36
Table 7. Table for Full 24-Hour DRM Coverage Option .....	37
Table 8. Notional CONOPS cost and limitations of each option presented. ....	42



## LIST OF ACRONYMS, ABBREVIATIONS, AND SYMBOLS

AIS	Automatic Identification System
AM	Amplitude Modulation
ANSIS	Arctic Navigational Safety Information System
AOR	Area of Responsibility
ASM	Application Specific Message
ATON	Aid to Navigation
ATU	Antenna Tuning Unit
BER	Bit Error Rate
bps	Bits per second
CFR	Code of Federal Regulations
CMTS	U.S. Committee on the Marine Transportation System
COMMCOM	USCG Communications Command
COMMSTA	Communications Station
CONOPS	Concept of Operations
CONUS	Continental United States
COTS	Commercial-off-the-Shelf
DAB	Digital Audio Broadcast
DOT	US Department of Transportation
DRM	Digital Radio Mondiale
DX'er	One who pursues distant transmissions
ECS	Electronic Charting System
eMSI	electronic Marine Safety Information
eNAV	electronic or enhanced Navigation
ETSI	European Telecommunications Standards Institute
FTP	File Transfer Protocol
FM	Frequency Modulation
GIS	Geographic Information System
GMDSS	Global Maritime Distress and Safety System
GPS	Global Positioning System
HD	Hight Definition
HF	High Frequency
HFCC	High Frequency Co-ordination Conference
Hz	Hertz (one cycle per second)
IF	Intermediate Frequency
IMO	International Maritime Organization
IP	Internet Protocol
ITU	International Telecommunications Union
kHz	kilo (1000) Hertz
kW	kilo (1000) Watts
LW	Long Wave
MDI	Multiplex Distribution Interface
MER	Modulation Error Ratio (digital communications)
MF	Medium Frequency





# HF Digital Radio Mondiale (DRM) Broadcast Summary Report

---

## LIST OF ACRONYMS, ABBREVIATIONS, AND SYMBOLS (CONTINUED)

MHz	Mega (1,000,000) Hertz
MPI	Message Passing Interface
MSC	Maritime Safety Committee
MSI	Marine Safety Information
MMSI	Maritime Mobile Service Identity
MW	Medium Wave
NAIS	Nationwide Automatic Identification System
NATO	North Atlantic Treaty Organization
NAVDAT	Navigational Data
NAVTEX	Navigational Telex
nm	Nautical Mile (1.108 miles)
NMEA	National Marine Electronics Association
NOAA	National Oceanic and Atmospheric Administration
NSI	Navigation Safety Information
NVIS	Near Vertical Incidence Skywave (antenna)
OFDM	Orthogonal Frequency-Division Multiplexing
OOD	Officer Of the Deck
PC	Personal Computer
QAM	Quadrature Amplitude Modulation
RCC	Rockwell Collins Control
RDC	USCG Research & Development Center
RF	Radio Frequency
RSS	Rich Site Summary, a.k.a. Really Simple Syndication
SDR	Software Defined Radio
SNR	Signal to Noise Ratio
TCP/IP	Transmission Control Protocol/Internet Protocol
TV32	Transview 32 (electronic chart system)
USB	Universal Serial Bus
USCG	United States Coast Guard
USCGA	United States Coast Guard Academy
USCGC	US Coast Guard Cutter
VAC	Volts Alternating Current
VDC	Volts Direct Current
VHF	Very High Frequency (30 MHz to 300 MHz)
VSWR	Voltage Standing Wave Ratio
W	Watt
WAN	Wide Area Network
XML	Extensible Markup Language



**(This page intentionally left blank.)**



## 1 INTRODUCTION

This report is an interim deliverable for the U.S. Coast Guard (USCG) Research and Development Center's (RDC) Next Generation Arctic Navigational Safety Information System (ANSIS) project. Reports on near-shore Automatic Identification System (AIS) broadcast and extended AIS Receive are also due for delivery in 2018. This report provides details of RDC's Alaska field test of a digital High Frequency (HF) broadcast prototype system designed to disseminate electronic marine and navigation safety information. It presents a notional Concept of Operations (CONOPS) and approximate cost for such a system and specific recommendations for a full implementation. The results of RDC's field test provides the foundation for the model upon which the CONOPS is based.

Maritime activity has increased in the Arctic, along with the potential for maritime accidents and serious environmental harm to the fragile Arctic environment. Lack of infrastructure and suitable communications capability coupled with the expanse of the Alaskan coastline makes traditional communication methods such as Very High Frequency (VHF) and AIS limited to nearshore. The aim of the ANSIS project is to explore electronic Marine Safety Information (eMSI) delivery solutions for nearshore, extended-range, and long-range. This report focuses on the long-range component using High Frequency (HF) digital radio broadcast.

## 2 DIGITAL RADIO MONDIALE AND JOURNALINE

Across the world, digital broadcasting is replacing traditional analog broadcasting systems, as digital methods offer increased transmission capacity and flexibility in the use of infrastructure. With a digital system, data may be transmitted as easily as audio recordings. Digital Radio Mondiale (DRM) is an international, open digital broadcasting standard that offers a dramatic improvement over the analog radios using amplitude modulation (AM) in all frequency bands, across large areas of the world [1].

### 2.1 DRM Standard

The U.S. Government adopted DRM as it recognized the robustness, audio qualities, power savings, and superior digital features. According to the Code of Federal Regulations (CFR; specifically, 47 CFR 73.75), an excerpt of which is included in Appendix A, "For digitally modulated emissions, the Digital Radio Mondiale (DRM) standard [2] shall be employed." The German Navy, a North Atlantic Treaty Organization (NATO) partner, is also exploring DRM and encrypted data transmissions for maritime broadcasting of information and entertainment to ships at sea. Other nations, including India, are adopting DRM as their primary means of radio broadcasting.

In September 2001, the first DRM standard was published by the European Telecommunications Standards Institute (ETSI) as ES 201 980. Later, in March 2012, ETSI published version 3.2.1 of this standard, which extends the DRM to the VHF bands, includes additional robustness, and surround sound support. Unlike other digital radio broadcasting standards, such as Digital Audio Broadcast (DAB) [4] and High Definition (HD) Radio, DRM covers all frequency bands. Moreover, it may be broadcast over HF using a robust data rate of 11,600 bits per second (bps) using a 10 kHz channel. This significantly higher data rate enables transmission of eMSI such as detailed weather information and maps, ice edge, and notice to mariners.



# HF Digital Radio Mondiale (DRM) Broadcast Summary Report

Additional background information on the DRM and its implications on electronic or enhanced Navigation (eNAV) initiatives can be found in Appendix H.

## 2.2 Journaline Standard

One of the greatest advantages of DRM is its ability to transmit a variety of data services without affecting the analog radio broadcasts in the area. The leading text information service for DRM is Journaline, which was developed by Fraunhofer IIS, a German research organization. Journaline has an extremely low bandwidth requirement, making it ideal for inexpensive consumer receivers. Like DRM, Journaline is an open standard. It is defined in ETSI standard TS 102 979. The DRM Journaline duo may be compared to a personal computer. DRM is like Ethernet and Journaline is like a stripped-down web browser.

Figure 1 shows how Journaline conceptually operates on the transmitting side. Fetcher/Formatters accept information from many different web feeds using tools such as Really Simple Syndication (RSS). This allows items of mariner interest, such as ice edge maps, high seas weather forecasts, and National Oceanic and Atmospheric Administration (NOAA) weather buoys, to be gathered. Journaline service may be seen as an RSS feed optimized for radio frequency (RF) transmission.



Figure 1. Fetcher/Formatters feed the Journaline service.

Figure 2 presents Journaline from an end user's perspective. The USCG Journaline Service appears in the upper left-hand corner of the screen. Like a web browser, the user can click on the item of interest. This particular screen capture is courtesy of Dr. Walter Salamiw, an amateur radio operator, who received the Coast Guard's Kodiak DRM broadcast in Victoria, British Columbia.



# HF Digital Radio Mondiale (DRM) Broadcast Summary Report



Figure 2. The end user reads the USCG Journaline service as if it was a web page.

## 2.3 State of the Market

The RDC conducted a market survey before embarking on a technical evaluation of the relatively new DRM technology. A wide range of DRM transmitters and receivers are already available in the consumer market, making it easy and relatively inexpensive to obtain Commercial-off-the-Shelf (COTS) DRM equipment. With the worldwide popularity of DRM, more investment and innovations are forthcoming, including home, portable, and car radios. Currently, the DRM receivers are available from multiple sources including:

- Professional, stand-alone DRM receivers, such as the RFmondial RF-SE19, are available and yield good performance as demonstrated later in this document.
- Mid-grade receivers / transceivers may be equipped with an analog 12 kHz Intermediate Frequency (IF) output. This signal enters the sound card of a Personal Computer (PC), which digitizes the signal so that software can perform the DRM demodulation. Some receivers have a digitized signal available through a USB interface, thus bypassing the sound card. The amateur radio operator who provided the Figure 2 image used one of these mid-grade transceivers and the DREAM open-source software package to demodulate the DRM signal and decode the USCG Journaline service.
- Software-defined radios are available. These physical devices are connected to, or occasionally installed inside, a PC. The PC can then use open-source or proprietary software to perform the DRM demodulation and Journaline decoding.
- Consumer-grade receivers are available. These may or may not be appropriate for the harsh marine environment (e.g., vibrations, moisture, powered fluctuations).



# HF Digital Radio Mondiale (DRM) Broadcast Summary Report

Software is a critical component for DRM and Journaline service. The market provides a mixture of proprietary and open-source options. There appears to be a cost, performance, and computer power trade-off as the various parties work to optimize their signal processing algorithms to obtain the best DRM reception.

## 3 FIELD TEST EQUIPMENT

This section briefly presents the DRM system that was field tested. For clarity, the detailed test descriptions have been moved to Appendix B. This section and the Appendices present the DRM system using simplified blocks as shown in Figure 3:

- Fetcher/Formatters create the Journaline (including data files) and AIS content (e.g. Data Channels) which is based on data pulled from the sources of interest such as; Marine Safety Information, weather maps, etc.
- The DRM modulator and transmitter convert the data to a RF signal which is broadcast over HF.
- Receiver: Receives the RF signal; and converts it back to the Journaline and AIS data.
- Display Data: shows the Journaline and AIS to the user.

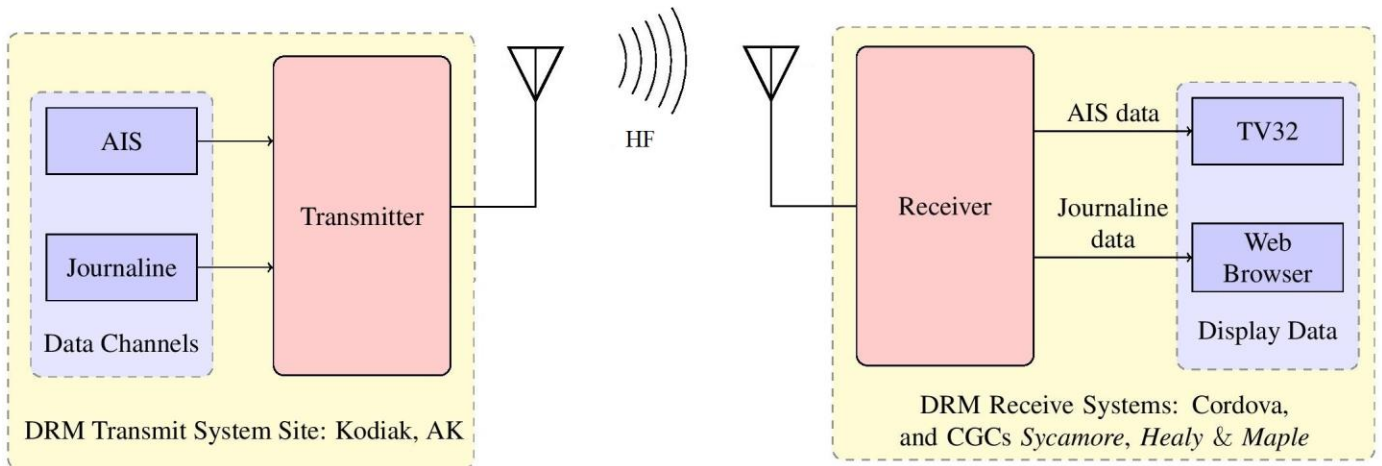

Figure 3. Block diagram of the DRM transmit and receive systems.

More information on each of these four DRM system “blocks” is given in the subsections below.

### 3.1 Data Channels: Fetchers/Formatters

The Journaline service provided by RFmondial came equipped with the ability to utilize modern data feeds such as RSS feeds. On a predefined schedule, the software fetches the data from the select web sites pictured in Figure 4, such as the NOAA weather forecast server and news servers. The data is formatted and passed to the USCG Journaline queue. All of these actions take place in the content server residing at the transmission facility as outlined in Section 3.3.

Data sources lacking the modern RSS feed, such as AIS, required additional software. An in-house developed Fetcher/Formatter application running on a dedicated PC aggregated AIS data collected from the



# HF Digital Radio Mondiale (DRM) Broadcast Summary Report

Internet. Data from pre-defined web addresses were periodically fetched. The data was formatted into a valid AIS message and passed to the content server for inclusion in the USCG DRM Service queue.



Figure 4. The Fetcher/Formatter software automatically builds the USCG DRM Service feed.



# HF Digital Radio Mondiale (DRM) Broadcast Summary Report

## 3.1.1 Information Broadcast

A wide range of information was broadcast, including weather, ice, virtual ATONs, news, and sports. The interval at which the data was broadcast was also variable. For instance, wind speed and direction is very dynamic and must be provided to the user at appropriate intervals (e.g., every 1 to 6 minutes). Ice maps and weather forecasts do not change as rapidly as wind speed and direction and can be provided to the mariner at longer intervals (e.g., hourly). More research is needed to determine the best intervals [5-7]. For this field test, three different DRM services were developed to support varying intervals for data transmission. These were the File Service, Journaline Service, and the AIS Application Specific Message (ASM) Service. DRM functionality allows the operator to choose services, data types, and bit rate for each service. The overall system provided for a bit rate of 11,600 (bits per second, bps).

Table 1 describes the data broadcast and file sizes associated with the File Service. For the field test, this service was used to transmit the largest data files: color weather and ice maps [8]. It used the greatest bit rate and took the longest time to transmit, 20 minutes.

Table 1. DRM File Service Summary

File Service Data Types	Average data size (in bytes)	# of files	Total Bytes
Weather Maps – Alaska <ul style="list-style-type: none"> <li>• NWS Alaska Current Weather Map</li> <li>• NOAA NE Pacific 24-hr Wind and Wave Forecast</li> <li>• NOAA NE Pacific 48-hr Wind and Wave Forecast</li> </ul>	130,000	3	390,000
Ice Maps <ul style="list-style-type: none"> <li>• NOAA Alaska Daily Sea Ice Concentration</li> <li>• NOAA Alaska 5-day Sea Ice Forecast</li> <li>• Canadian, 10-day Ice History</li> </ul>	200,000	3	600,000
Total Bytes			990,000
<i>File Service Bits</i>		<b>7,920,000</b>	
<i>File Service Bit Rate (set by RDC)</i>		<b>6,320</b>	
<i>File Service Time to Transmit (in minutes)</i>		<b>20.95</b>	

Table 2. Describes the data broadcast and file sizes associated with the Journaline Service. For the field test, this service had the greatest variety of data and the medium interval, taking 14 minutes to transmit.





## HF Digital Radio Mondiale (DRM) Broadcast Summary Report

Table 2. DRM Journaline Service Summary

Journaline Service Data Types	Average data size (in bytes)	# of files	Total Bytes
NAVTEXT Forecast (includes Alaska Coastal Waters Forecasts, Offshore Forecasts, High Seas Forecasts [9])	25,000	3	75,000
Marine Safety Information Bulletin	2,000	1	2,000
Marine Forecasts from various sites	3,000	10	30,000
NOAA data buoy information	1,000	20	20,000
ESPN Sports Reports	3,000	15	45,000
Google Top News Stories	3,000	15	45,000
Total Bytes			217,000
<i>Journaline Service Bits</i>		<b>1,736,000</b>	
<i>Journaline Service Bit Rate (set by RDC)</i>		<b>2,060</b>	
<i>Journaline Service Time to Transmit (in minutes)</i>		<b>14.05</b>	

Table 3 describes the data broadcast and file sizes associated with the AIS ASM Service. For the field test, this service transmitted actual AIS messages in binary format. The lowest bit rate was used because the data sizes are relatively small, but the dynamic nature of the data required these messages to be sent at least every minute.

Table 3. DRM AIS ASM Service Summary

AIS ASM Service Data Types	Average data size (in bytes)	# of files	Total Bytes
U.S. National Ice Center/Naval Ice Center - Ice Edge	160	10	1,600
Various Alaskan weather station data	160	10	1,600
Virtual AtoNs	160	2	320
NOAA data buoy information (also provided in text form in Journaline Service)	160	6	960
Total Bytes			4,480
<i>AIS ASM Service Bits</i>		<b>35,840</b>	
<i>AIS ASM Service Bit Rate (set by RDC)</i>		<b>933</b>	
<i>AIS ASM Service Time to Transmit (in minutes)</i>		<b>0.64</b>	



### 3.2 Transmitter System

Figure 5 shows the field test transmitter system as installed for the Alaska field testing at Communications Station (COMMSTA) Kodiak. Figure 6 represents the block diagram of the overall transmit system. The transmitter architecture consisted of an HF transmitter, HF antenna, desktop control computer, content server, DMOD3 modulator, RF sampler, and Ethernet switch. All of these pieces of equipment were either COTS or were already owned by USCG. RFmondial supplied COTS equipment, and COMMSTA Kodiak offered the USCG-owned equipment.



Figure 5. (Left) Kodiak HF transmitter #12 (tall cabinet on end of row closest to viewer) and portable server rack. (Right) Close-up of the portable server rack housing the content server, DMOD3 modulator, and Ethernet switch.

# HF Digital Radio Mondiale (DRM) Broadcast Summary Report

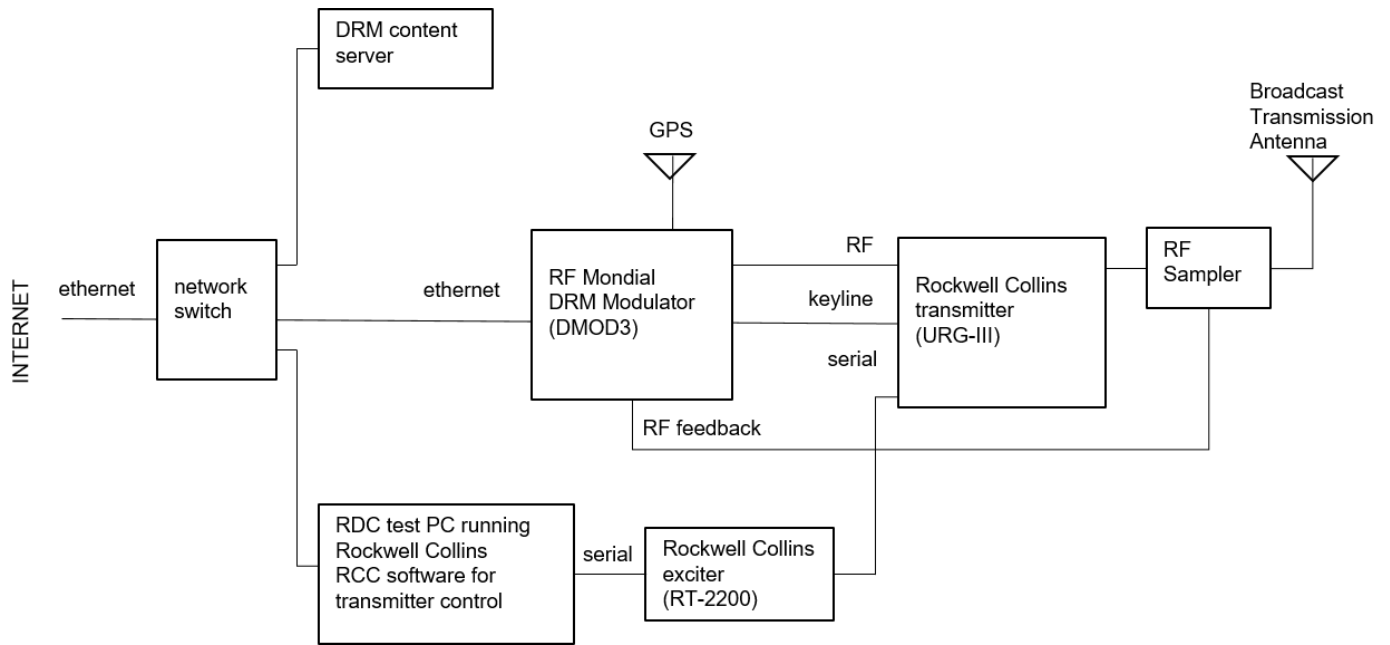

Figure 6. Kodiak HF DRM Transmit System installation block diagram.

The content server controls the flow of the user-defined information into a single data stream, which feeds the DRM modulator through the network switch. This modulated signal is then output to the transmitter as a low-level RF signal. Since the modulator is configured to output the modulated RF signal at the desired carrier frequency, it could also be considered as an exciter. The transmitter receives the low-level RF signal from the modulator and amplifies it before outputting to the antenna. To control the desired transmission power, the transmitter can adjust the amplitude of the RF signal generated by the modulator. Below is additional technical information on each of the components in Figure 6:

- **Content Server.** The content server provides an easy way to gather data from the web, databases or specified files and multiplexes them onto the transmit stream. In this field test, the RDC used RFmondial/Fraunhofer's DRM30 content server.
- **Modulator/Exciter.** The RDC used Transradio DMOD3 in this test due to its ability to integrate with existing/nonlinear amplifiers by adjusting the shape of the modulated spectrum to compensate any nonlinearities generated by the amplifier. This feature is necessary for limiting out-of-band transmissions that may interfere with other RF transmission frequencies. It generates the Orthogonal Frequency-Division Multiplexing (OFDM) signal using either 16 or 64 level Quadrature Amplitude Modulation (QAM) as well as other specific DRM settings (per Appendix A).
- **Transmitter/Exciter.** For this test, the RDC used one of the existing Rockwell Collins URG-III 4kW transmitters at COMMSTA Kodiak. Although not shown in Figure 6, the RDC also utilized an existing Rockwell Collins RT-2200 exciter to control the amplifier. Although the DMOD3 modulator supplied the modulated signal for the system, the exciter was controlling the amplifier functions such as power level and frequency band.
- **Transmission Antenna.** The RDC used the existing TCI 530-3 and TCI 550-4 broadcast antenna at COMMSTA Kodiak for the test. As an omnidirectional Near Vertical Incidence Skywave (NVIS) antenna, TCI 530-3 is known for its ability to broadcast over short distances, especially where the terrain includes



## HF Digital Radio Mondiale (DRM) Broadcast Summary Report

obstacles such as the Alaskan mountain ranges. On the other hand, TCI 550-4 provides both ground wave and skywave coverage over a wide frequency range. Appendix E presents the radiation pattern for each antenna.

### 3.3 Receiver System

The RDC purchased two DRM receivers. Initially, the RDC installed one receiver system in Cordova, AK, on the USCG Cutter (USCGC) SYCAMORE, and the other in SYCAMORE's shore support building. Later, the RDC moved one receiver to the USCGC HEALY and the other to the USCGC MAPLE.

Figure 7. Alaska field test receive installation (Laptop and DRM Receiver). shows a representative receive installation. Appendix B provides additional information and photos of the field test installation.



Figure 7. Alaska field test receive installation (Laptop and DRM Receiver).

Figure 8 shows the equipment and connection block diagram for the receive installation. The HF receive antenna receives the HF signal which is then fed into the RFmondial DRM receiver. The DRM receiver decodes the signal received from Kodiak and displays it on the RDC laptop computer through the DRM browser interface and government-off-the-shelf Electronic Chart System (ECS) called Transview 32 (TV32). The shipboard AIS receiver provides other ship position reports to TV32 via an external connection called the “pilot plug” on the shipboard AIS unit. The Ethernet device provides an interface between the receiver, the laptop, and the shipboard internet.



# HF Digital Radio Mondiale (DRM) Broadcast Summary Report

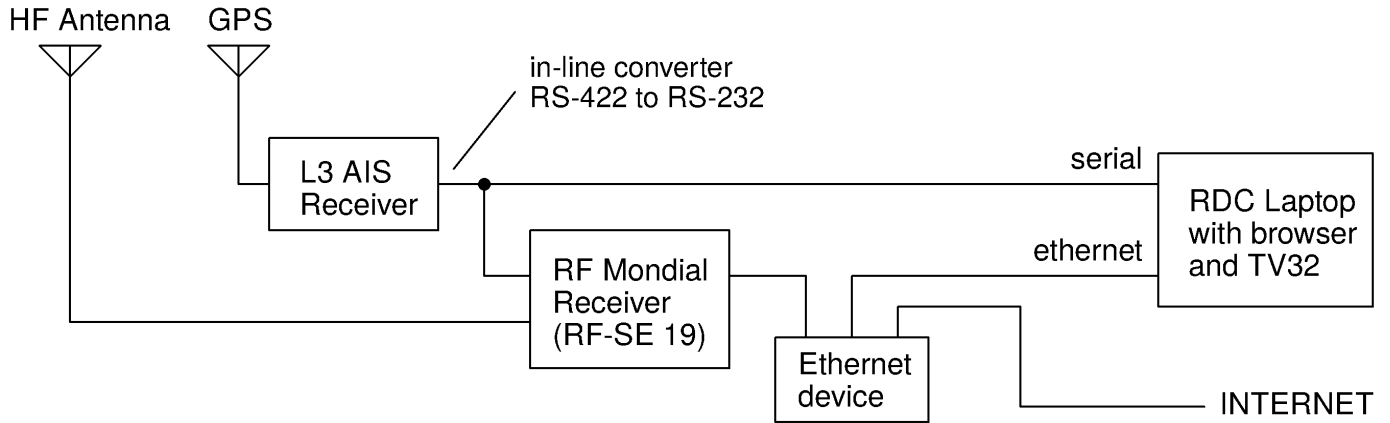

Figure 8. HF DRM receive installation block diagram.

The receiver system, as shown in Figure 8, is comprised of three primary components:

- **Receiver.** The DRM receiver receives the broadcast from a connected antenna and decodes (demodulates) the signal. Then, Fraunhofer's Multimedia Server displays the aggregated data (hosted on the receiver) by pointing a web browser to the receiver's IP address. In addition to allowing access to the transmitted data, the receiver also logs detailed information about the broadcast, such as signal-to-noise ratio (SNR), bit error rate (BER), and modulation error ratio (MER). For this test, the RDC used two identical RFmondial RF SE-19 single-unit, rack-mounted receivers. The receivers employ an Ethernet web host to allow the connection of any number of users using any device with an Internet browser.
- **Receive Antennas.** The initial two receiver sites were both located in Cordova: one on shore, and another on the USCGC SYCAMORE. For the shore receiver, the RDC used a directional loop antenna. Loop antennas display a high reception gain in the direction of the received signal. Per RFmondial's recommendation, the RDC used Wellbrook Communications ALA1530LNP broadband magnetic loop. On the USCGC SYCAMORE, the RDC added an omnidirectional fiberglass HF whip antenna, a Shakespeare 5390 Galaxy HF/SSB 17'6" antenna, which is identical to the existing antennas on the ship. As mentioned earlier, after the initial experiment at Cordova, the RDC moved the receivers to USCGC HEALY and USCGC MAPLE. In both cases, the RDC utilized the existing shipboard HF antennas.
- **L3 AIS Receiver.** Underway Global Positioning System (GPS) time and position data were provided by each vessel's existing L3 AIS receiver.

## 3.4 Display Systems

The transmitted DRM data was configured for three digital streams. The Journaline and File data were viewed using a web-like interface for the Journaline Channel, while the AIS data were viewed using the Transview (TV32) display.

### 3.4.1 Journaline Channel

Multimedia data are viewed by pointing a web browser on the network to the receiver's IP address. This directs the user to the receiver's internal multimedia player which allows viewing the transmitted user content as well as a real-time view of the broadcast details. Figure 9 shows a sample Journaline service as



# HF Digital Radio Mondiale (DRM) Broadcast Summary Report

viewed by the end user in the RDC field test. The root level display is on the left and a representative weather map is on the right.

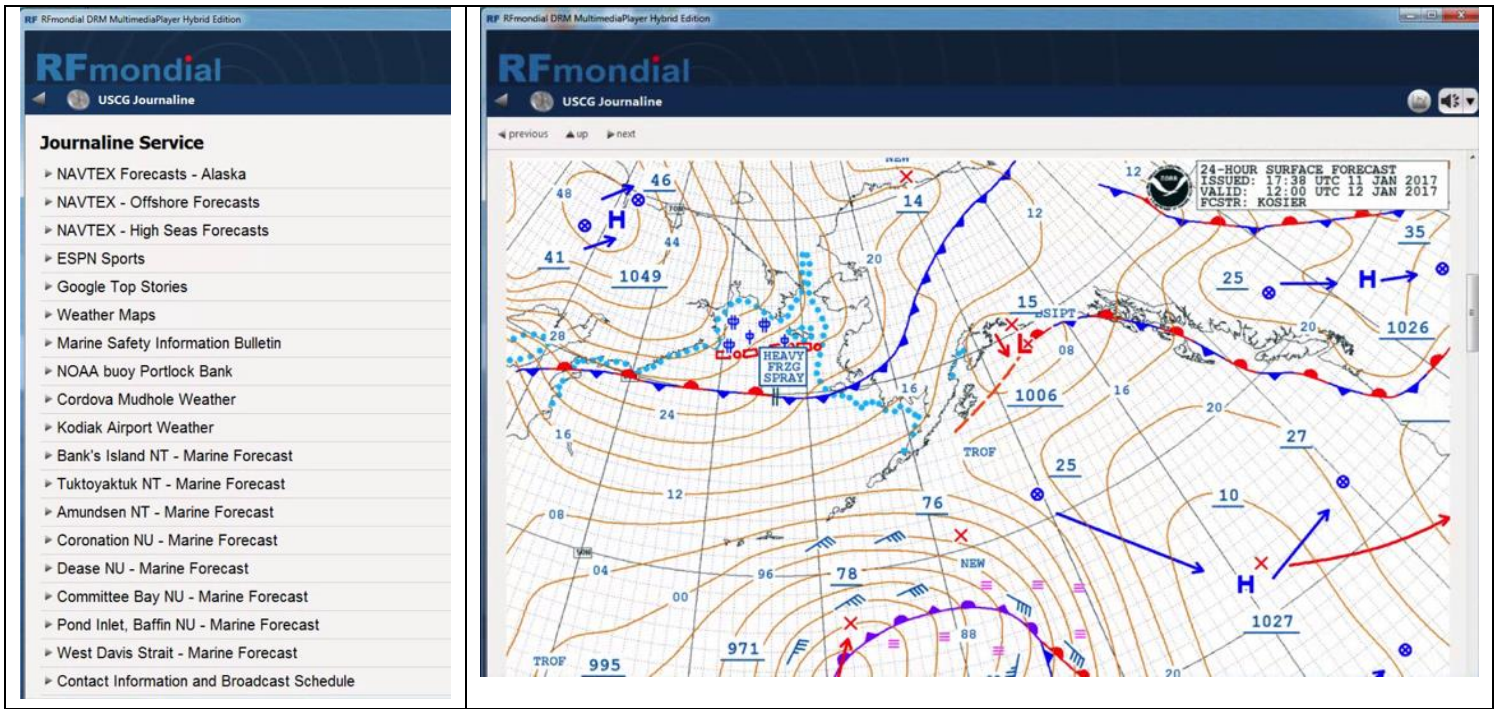

Figure 9. Journaline’s root level display (left) and representative weather forecast (right).

## 3.4.2 AIS Channel

For the DRM tests, the RDC used Transview (TV32), a Geographic Information System (GIS) that was developed by the United States Department of Transportation (DOT). TV32 is connected to the Transmission Control Protocol/Internet Protocol (TCP/IP) port allocated for the asynchronous serial stream. Weather buoy, weather station, and ice edge data were the primary sources of AIS channel data. Figure 10 portrays these data as seen on the electronic chart system, TV32. Specific web links to these AIS data sources, along with additional screenshots of the data portrayed on the laptop, can be found in APPENDIX C.



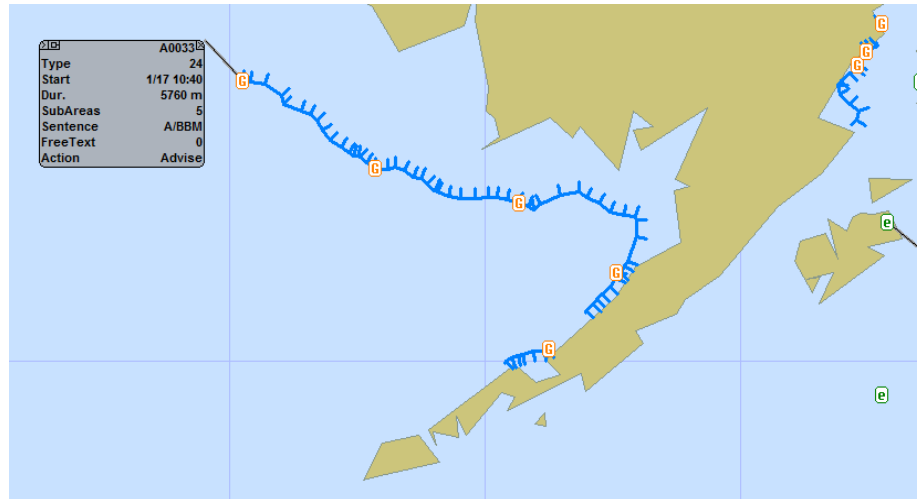

Figure 10. Representative AIS-based ice edge as displayed on TV32.

## 4 SUMMARY OF METHODS

The field test ran from October 2016 to September 2017. The shore-based monitor receiver was located inside the USCGC SYCAMORE's shore support building and the mobile installation was aboard the USCGC SYCAMORE. Both located in Cordova, AK. Mid-way through the testing (June 2017) the two receivers were relocated; one to USCGC HEALY (in April 2017), which was participating in Arctic Technology Demonstration and one to USCGC MAPLE (in June 2017), which was transiting the Northwest Passage.

The transmitter was operated continuously, with broadcast frequencies changed every 2 or 3 days (changed on Mondays, Wednesdays, and Fridays at 1600 UTC). The broadcast schedule can be made available upon request. Ten frequencies were requested and authorized by CG-6 (2.45, 5.20, 6.85, 8.00, 9.90, 12.1, 18.6, 22.6, 24.0, and 29.9 MHz). After initial testing and reviewing propagation predictions, we decided to use only the lower six frequencies, as the higher frequencies did not appear to have the desired range. When the transmissions were switched to the TCI-550 antenna, we had to drop the 2.45 MHz frequency as the Voltage Standing Wave Ratio (VSWR) was too high, causing transmitter problems.

There were some transmitter off-air periods due to antenna or system maintenance at COMMSTA. Many of the faults were due to problems with the RCC software; mostly caused by insufficient disk space. There was an extended period of off-air time due to failure of the DMOD3 modulator (twice). Details of these failures are provided in the section below.

The RCC program logged various transmitter parameters at a rate of 8 times per minute. The parameters of interest are forward power and reflected power. The data was saved into log files on a 30-minute interval.

The RF Mondial receivers logged various parameters at a rate of about 3 times per second. The parameters of interest are number of bits received, number of bit errors, the receiver frequency, signal strength, and SNR. The data was saved into daily log files.

User feedback was collected aboard the USCGC HEALY and from amateur radio operators. Specific details can be found in Section 5.2.



## 5 EVALUATION

This section highlights the events that occurred during the field test from October 2016 to September 2017.

### 5.1 Equipment Functionality

The following describes equipment functionality and problems which occurred during the field test.

- **Modulator/Exciter.** Although the manufacturer had reported a very low failure rate for the modulator, the RDC experienced two major failures in the course of field testing. The first failure appeared to be a hard drive failure. Despite the vast distance between the location of manufacturer (Germany) and installation location (Alaska), the RDC was able to replace the hard drive relatively quickly. After this remedial action, the RDC observed no other hard drive failure. The second failure, which occurred in the RF board, could have been caused by a fault in the transmitter or antenna at Kodiak. Unfortunately, there was not any real-time monitoring of the conditions when the failure occurred, impeding more accurate troubleshooting.
- **Transmitter/Exciter.** The existing USCG transmitter worked well for this application despite the initial concerns over the modulation type and continuous operation. There were only a few minor faults or maintenance outages during the test. The power levels and VSWR, were all acceptable across the frequency range.
- **Content server.** The Fraunhofer content server worked very well and experienced no faults or issues during the test. During the test, the RDC added an input for Navigational Telex (NAVTEX) data that was able to grab the data from the existing NAVTEX Internet feed, requiring no changes on the part of the content provider.
- **Transmission Antenna.** Both the TCI 530-3 and TCI 550-4 antennas functioned well in DRM digital transmit with low VSWR. However, the reception in Cordova appeared to be better when using the TCI-550 antenna.
- **Receiver.** The RFmondial receivers functioned without failures on all of the installations. Despite requiring some software updates, the receivers were very easy to work with.

### 5.2 User Feedback

User feedback was gathered aboard the USCGC HEALY during its Arctic Technology Demonstration in July and Aug 2017. During this time, a project team member provided training on the shipboard DRM system, observed usage of the system and interviewed individuals as to the data's usefulness.

Part of the DRM broadcast included contact information and broadcast schedule. It is through this information that amateur radio operators contacted the project team. RDC made Follow-up emails and phone calls to collect user data, primarily the receivers and software used to decode the DRM signal.

#### 5.2.1 Analysis of USCGC HEALY Crew and Guests Users

The HF coverage throughout this four-week deployment from July 21 to Aug 17, 2017 appeared to be satisfactory. The equipment functioned the entire time, although there was one occasion where the RDC laptop needed to be rebooted. While underway, the RDC introduced the DRM laptop to the crew of the





## HF Digital Radio Mondiale (DRM) Broadcast Summary Report

---

USCGC HEALY who were present on the bridge (e.g., Officer Of the Deck (OOD), watch standers, and navigation team). The laptop was capable of showing both AIS data (through TV32) and Journaline channels. The goal for this prong of the test was to evaluate the usefulness of the wide range of detailed graphical and textual information to the ship's crew. While underway, the information, such as marine and navigation safety information, news and sports, would normally only be available through access to the Internet on or near shore. The USCGC HEALY crew pointed out the utility of the timely weather and navigation safety information on the laptop. According to the crew, the USCGC HEALY receives the maritime safety information through separate equipment (Safetynet, NAVTEX, etc.). This requires that one of the crew on duty on the bridge must temporarily leave the front of the bridge, walk to the distress signal equipment, read the information, and return to the bridge. In addition, the crew pointed out that since the USCGC HEALY is minimally manned, there is no person assigned to the ship that would provide in-house review and analysis of these weather and ice maps. The crew has procedures in place through satellite and other communication (e.g., NAVTEX, SafetyNet), to receive weather and safety information. However, this information is primary textual. Having the weather map and navigation safety information included on the AIS/Journaline software mitigates these two shortcomings.

The ship's crew expressed their satisfaction with the HEALY's AIS and charting capabilities and did not feel any need for using the RDC's TV32. However, they also mentioned that receiving the live weather feeds and ice edge information overlaid on their charting system could be a welcome addition to their existing ECS. The crew also recommended addition of multiple useful TV32 features such as sounding an alarm when a ship is approaching a specified hazardous zone, saving the AIS log of the ship, and the ability to export the ship's contacts. These features could assist any potential post-incident reports as well.

In parallel, the RDC encouraged the ship's science team and other guests to access Journaline through typing a particular Internet Protocol (IP) address on their cell phone's browser, to access the ship's WiFi, which was connected to the output of the DRM receiver. The goal for this second prong of the test was to evaluate the quality and user-friendliness of the DRM-based Navigation Safety Information (NSI) data, news, and sports on their personal electronic devices (e.g., cell phones). Almost every area of the ship had Journaline access, except the galley and the gym, on the two lowest decks of the USCGC HEALY. The access to Journaline was simple and the speed of loading information on the cell phones was impressive. Figure 11 shows an example of the DRM data displayed on a mobile phone.

The availability of constantly-updated marine and navigation safety information, news, and sports while underway in remote regions of the Arctic was well-received by the users. The participants were excited to read the latest news and weather forecast on their cell phones without having to utilize expensive onboard satellite telecommunications infrastructures. All the information was received onboard via the HF DRM prototype installed by RDC. However, not all the news stories were always loaded, and some of those that were sometimes displayed only the beginning of the story. In addition, some of the white spaces within the text of the news story were formatted poorly. The participants also have shown interest in receiving graphic AIS ASM information on their handheld devices, as opposed to the current textual format.

In summary, both methods to access DRM data (i.e., AIS and Journaline) proved to be useful and user-friendly according to the test participants.



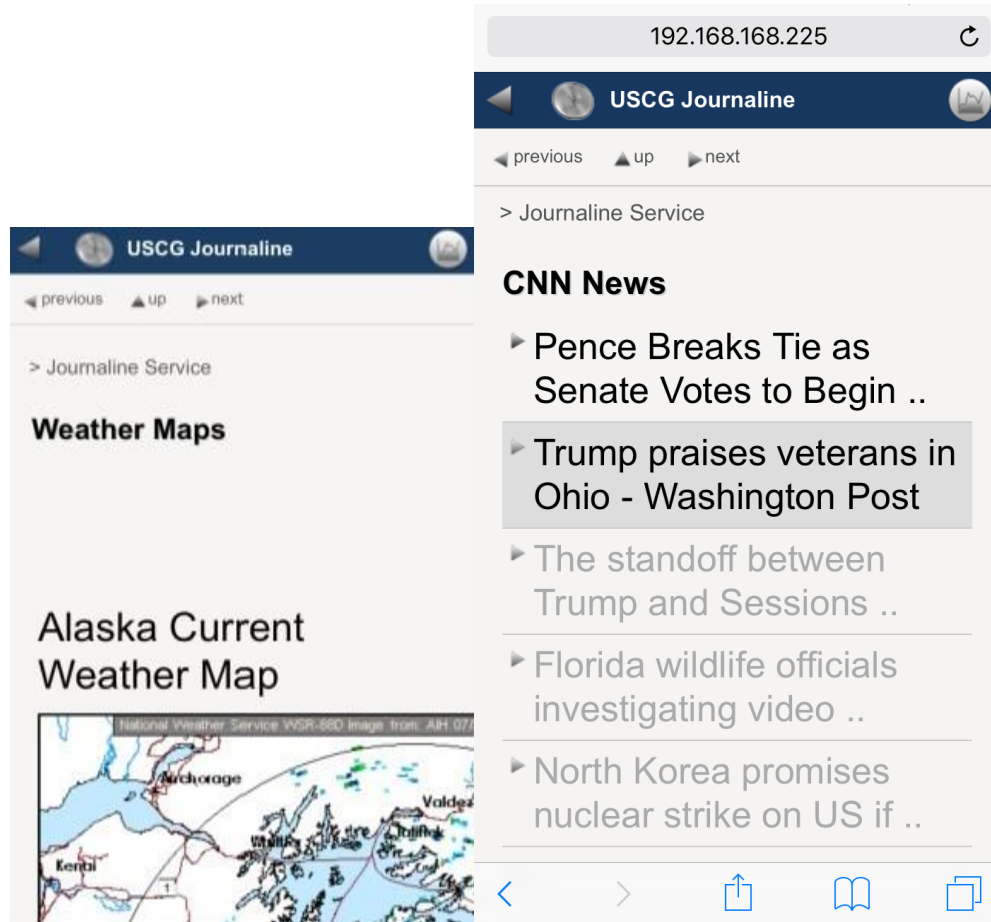

Figure 11. DRM data displayed on a mobile phone. (Left) Phone display of Weather Map. (Right) Mobile phone display of News.

## 5.2.2 Analysis of Amateur Radio Users

Several amateur radio users from Mojave Desert, California, Bellingham, Washington, Virginia, and Victoria, British Columbia received the RDC's DRM broadcast and sent screenshots of the received Journaline services to the project team as requested. See Figure 2 for an example of these screenshots. These users used open-source software to decode DRM. Overall, they were satisfied with the quality and content of the Journaline service. An article written by Larry Van Horn, call sign N5FPW, on the USCG DRM testing can be found in Appendix F.



## 6 ANALYSIS OF THE DRM DATA

The Rockwell Collins Control (RCC) program running on RDC's control computer (see Figure B-3) logged various transmitter parameters at a rate of eight times per minute. The parameters of interest are forward power and reflected power. The data was saved into log files on a 30-minute interval. The data demonstrated the reliability of the Coast Guard's Rockwell Collins 4 kW URG III HF transmitter and identified the few times when the DRM signal was off the air. These data are available upon request. Data from each RFmondial receiver were recorded on the hard drive and backed up to a universal serial bus (USB) thumb drive. The parameters of interest include the number of bits received, number of bit errors, the receiver frequency, signal strength, and signal-to-noise ratio (SNR). Each parameter was recorded at a rate of about three times per second. The data was post-processed due to the resulting large file size. An analysis of the data is presented in the following section.

### 6.1 Propagation and Model Validation

The analysis of a HF radio link is a complex process as the HF signal is affected by broadcast frequency, transmitter power, antenna type, and modulation method. It is also sensitive to seasonal, diurnal, and even solar weather as indicated by sunspot activity. These relationships are explored in Appendix D, which provides an introduction to the modeling used in this report. The remaining sections of this report are written assuming the reader is familiar with the Appendix D content.

#### 6.1.1 Kodiak to Cordova Link

There are many ways to analyze the DRM data. For brevity and alignment with the HF propagation model describe in APPENDIX D, only the Signal-To-Noise Ratio (SNR) will be considered. Representative data are included in Figure 12 to show how the SNR varies over a specific day and fits the monthly propagation model. It presents the SNR for Kodiak's 5200 kHz signal as measured by the Cordova DRM receiver on 10 Dec 2016. For clarity, the data is smoothed using a 10-minute average. This low-frequency signal's propagation is similar to the example presented in Figure D-2; the signal is only available in the evening hours.



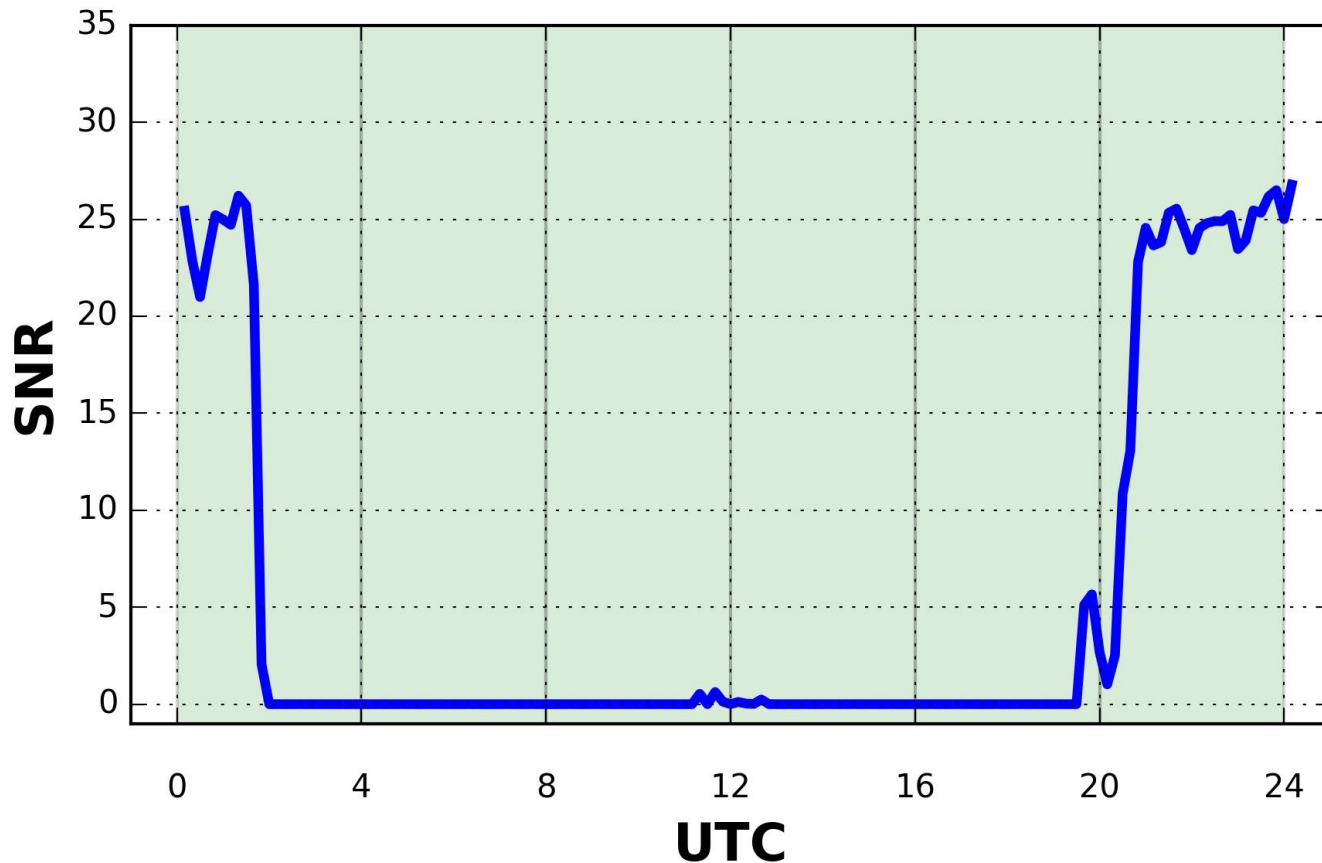

Figure 12. Representative signal strength for Cordova reception (December 2016 – 5200 kHz).

Throughout the 24 hours of analysis shown in Figure 12, the propagation forecast of the Spectrum-E model, closely matched the recorded reception at Cordova receiver. Therefore, the above plot is marked with green (i.e., “matched”) for the entire time.

Figure 13 presents the corresponding Dec 2016 propagation forecast for the 5200 kHz signal broadcast from Kodiak, AK. The model generated in the ATDI Spectrum-E tool is based on the following assumptions:

- The minimum SNR is set to 15 dB. This value was empirically determined based on best fit for the field-collected data.
- The sunspot number was set to the observed value of 18.5 for the month of December 2016.
- The Kodiak transmitter output power was modeled as 3,000 watts (W) with 1 dB loss into a TCI-530 antenna.
- The DRM bandwidth is modeled at 10,000 Hertz (Hz).
- The noise floor is set to -140 dBW/Hz which is consistent with a shipboard environment.



# HF Digital Radio Mondiale (DRM) Broadcast Summary Report

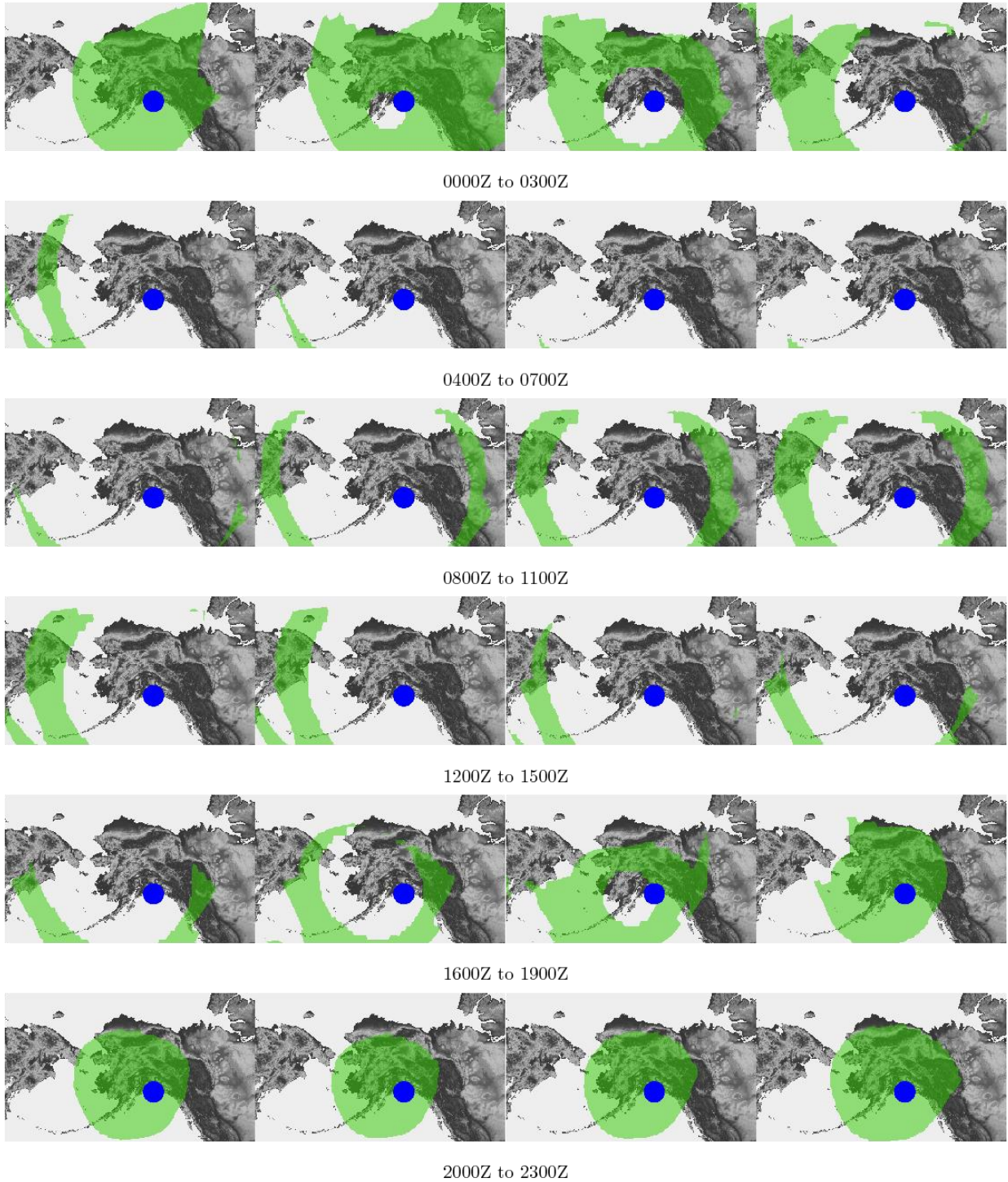

Figure 13. Kodiak DMR 24-hour forecast coverage (Green) for December 2016 at 5,200 kHz. Cordova, AK, is highlighted in Blue.



## HF Digital Radio Mondiale (DRM) Broadcast Summary Report

---

Figure 13 includes 24 predictions to show how the signal changes over each hour. Each of these 24-hour vignettes corresponds to the graph in Figure 12. Figure 12 and Figure 13 show a high degree of correlation. In Figure 13, the blue dot represents Cordova and the green field identifies locations where the SNR is sufficient for DRM reception.

In Figure 13, Cordova is “in the green” in the Coordinated Universal Time UTC evening (actually Alaskan day, but all further references will be to UTC) and in the daytime is inside the skip zone, which refers to the propagation of radio waves reflected or refracted back towards Earth from the ionosphere. This same pattern is shown in Figure 12 as the received SNR is high in the evening and absent in the day. Unfortunately, the distance between Kodiak and Cordova left something to be desired: the distance is greater than the ground wave can travel, yet it is too close for the sky wave on all but the lowest frequencies. Consequently, little data was received in Cordova as the Kodiak broadcast frequency was changed every 2 to 3 days. Figure 12 and Figure 13 are representative of this portion of the field test; additional data are available on request. Due to a failure of the USCGC SYCAMORE antenna, no data were available.

The Cordova phase of the test ran from November 2016 to April 2017. RDC used the Kodiak to Cordova phase of the test to explore various DRM robustness options and broadcast antenna configurations. Ultimately, the skip zone problem severely limited the analysis. RDC moved the locations of the receivers to USCGC HEALY (in April 2017) and USCGC MAPLE (in June 2017).

### 6.1.2 Kodiak to USCGC HEALY and MAPLE

The second phase of the DRM field test used Kodiak as the transmit site and underway vessels in the Arctic as the receive sites. The Kodiak shoreside installation and the USCGC HEALY and USCGC MAPLE installations are described in Section 3.2 and Appendix B.2. The data collected by these vessels are the keys that enable future predictions of the DRM system.

Since both USCGC HEALY and USCGC MAPLE were underway and covering large distances, plots were prepared to help visualize the vessels’ track lines and the areas where they had signal reception. A plot for all frequencies for the USCGC HEALY is shown in Figure 14. A plot for all frequencies for USCGC MAPLE is shown in Figure 15. In each plot, the cutter’s track line is shown in magenta; the track line is marked in black for periods of time when the transmitter was off-air (no reception possible). Signal reception and strength at each point where there was reception is indicated by the colored shading (yellow to blue, with blue being the best) of the track line (strength scale to right of plots). The transmitter location is marked by the red asterisk.



# HF Digital Radio Mondiale (DRM) Broadcast Summary Report

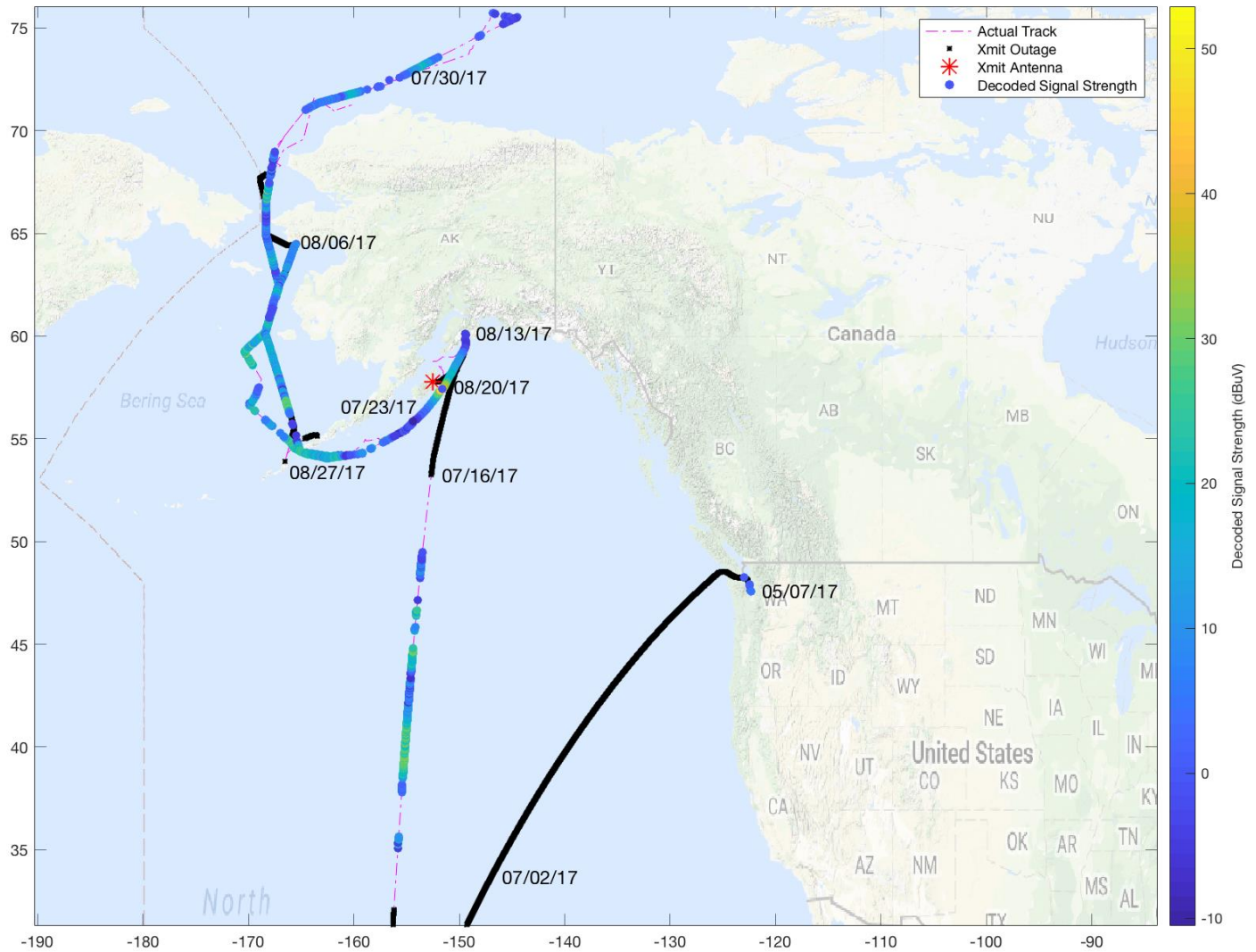

Figure 14. USCGC HEALY reception, all frequencies.

USCGC HEALY had very good reception at the three lowest frequencies (5.2, 6.85, and 8 MHz). Reception was much more sporadic at the higher frequencies (9.9 and 12.1 MHz).



# HF Digital Radio Mondiale (DRM) Broadcast Summary Report

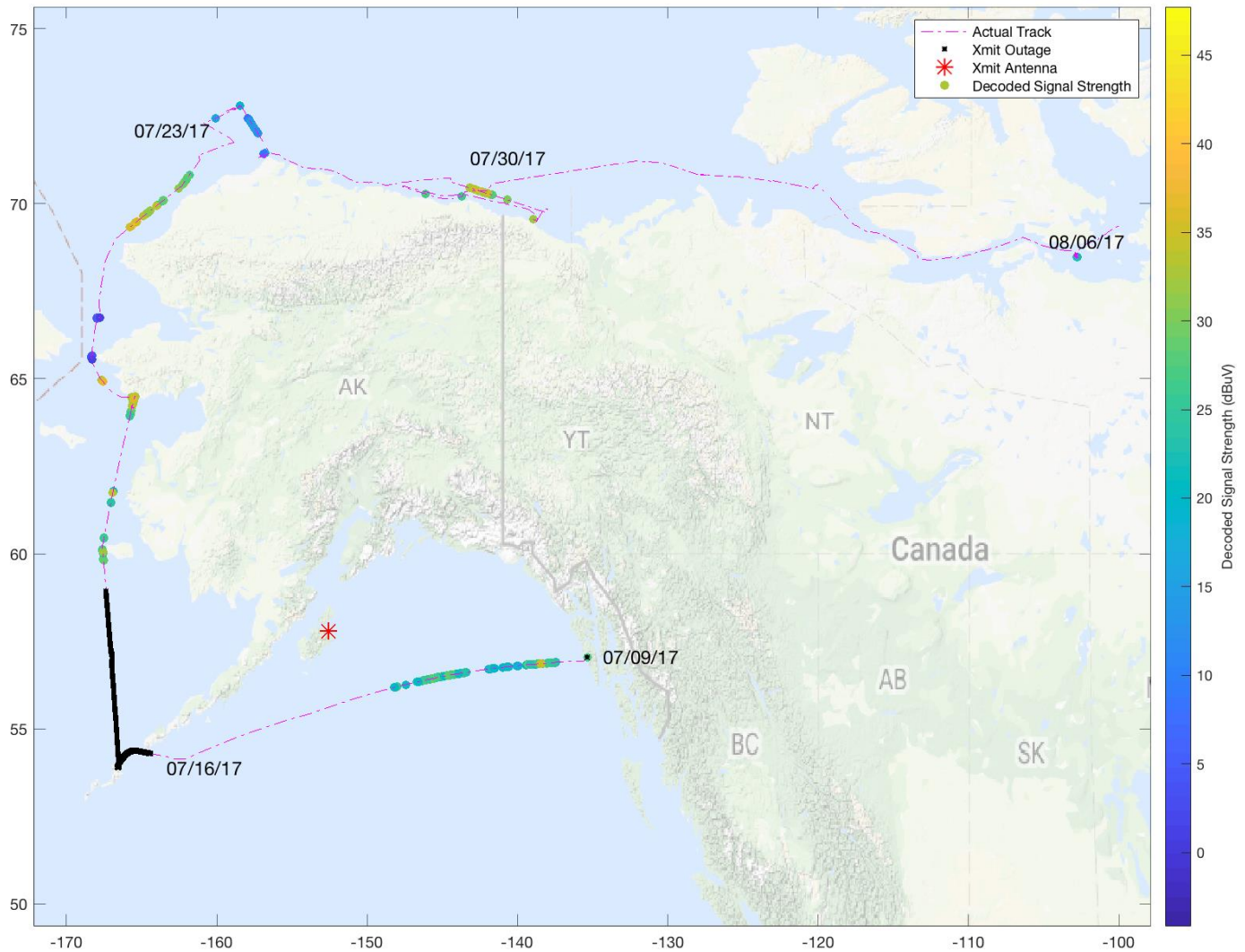

Figure 15. USCGC MAPLE reception, all frequencies.

USCGC MAPLE had less success at reception; but this may have just been a case of poor timing. When the MAPLE left port, the transmitter was on 6.85 MHz, and MAPLE had reception for most of the time. When the transmissions were switched to the higher frequencies, reception suffered; however, there was some reception at all frequencies. When the transmitter was on 5.2 MHz, which was typically the best, MAPLE was North of Alaska and Canada.

A more detailed frequency by frequency analysis of underway reception data was performed. A sampling of this underway data is shown in Figure 16 to Figure 21. Additional underway data can be found in Appendix G. The figures occur in groups of three. For example, Figure 16 shows the July forecast (green) for a 6850 kHz DRM signal originating from Kodiak. The average position of USCGC HEALY for 22 Jul 2017 is shown in red and the average position of USCGC MAPLE is shown in cyan. Figure 17 shows the SNR of each vessel with USCGC HEALY in red and USCGC MAPLE in cyan. The colors were chosen to match the average vessel position as shown in Figure 16. The Spectrum-E model was configured using the same setting as shown in the Kodiak to Cordova link (Section 5.1.1).





## HF Digital Radio Mondiale (DRM) Broadcast Summary Report

---

To better understand the empirical methodology used to support the model, each 4-hour period is assigned one of three categories, based on observed correlation of the data to the model's graphics.

- **Match:** suggests the model is a good fit to the field data; the reception data closely matches the predicted coverage for the given period.
- **DRM Outperforming:** suggests the actual field data are better than predicted in the model
- **DRM Underperforming:** suggests the actual field data are poorer than predicted in the model.

The background of each signal to noise graph has been color coded as green, blue, or red, representing Match, DRM Outperforming and DRM Underperforming respectively. For example, the six, four-hour sections, in Figure 12 are Green. This demonstrates that for all 24 hours there is a very good match between model and field data. Figure 17 for the USCGC HEALY, the DRM is outperforming to model (six sections of blue) as HEALY is always within the skip zone. In this instance, HEALY is receiving a ground wave, which the SPECTRUM-E model is not configured to display. In Figure 17, the field data for USCGC MAPLE slightly underperforms when compared to the model, with its two red sections and four green sections.

When the Match, DRM Outperforming and DRM Underperforming numbers are tallied for Figure 16 through Figure 21 and those found in Appendix H, we see the model is:

- Match (green) 64% of the time (actual reception data and model match).
- DRM Outperforming (blue) 23% of the time (reception data better than model).
- DRM Underperforming (red) 13% of the time (reception data poorer than model).

Considering the “DRM Underperforming” is only 13%, this indicates that the model can be relied on for planning these broadcasts for 87% of the time.



# HF Digital Radio Mondiale (DRM) Broadcast Summary Report

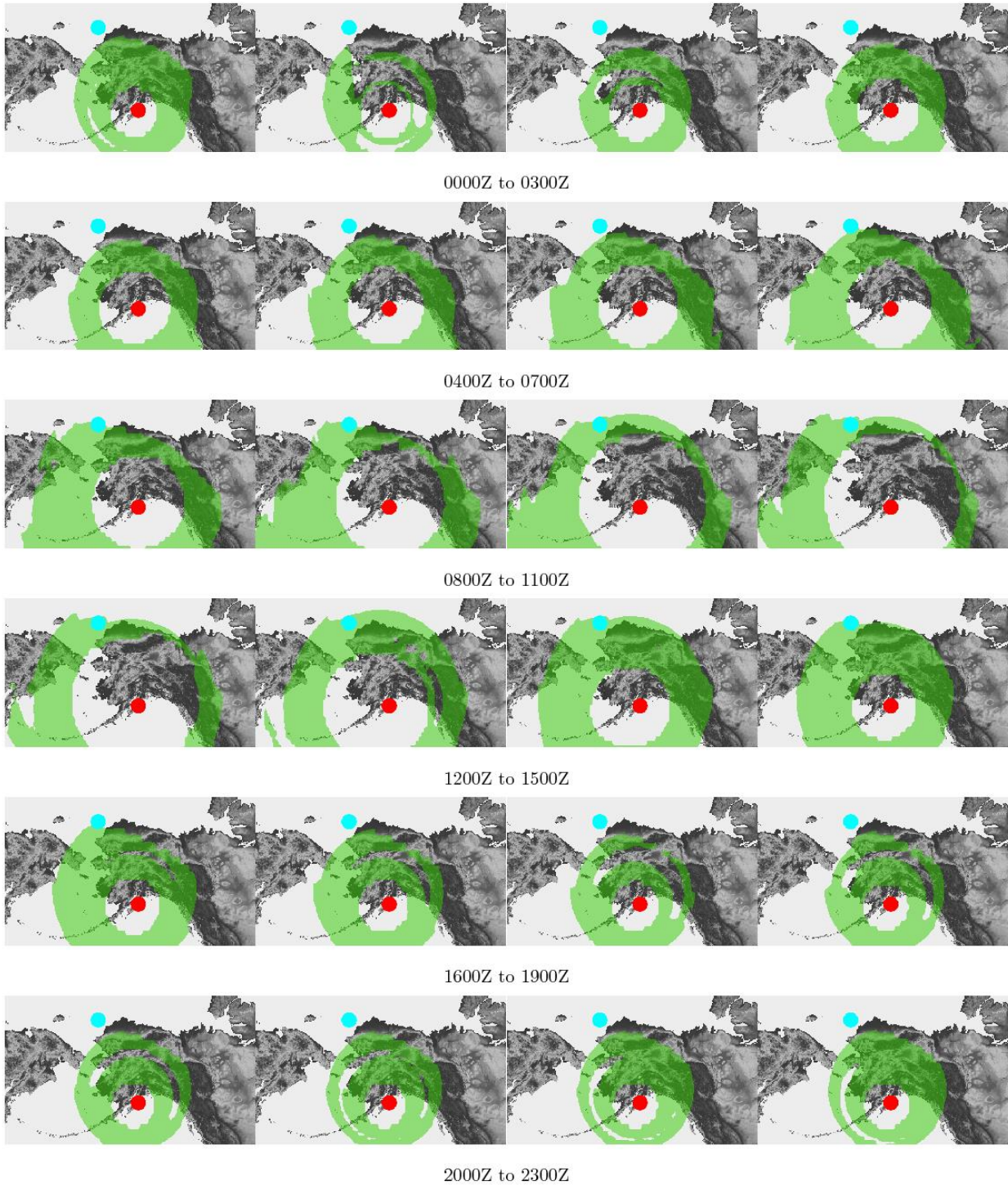

Figure 16. Jul 22, 2017 forecast coverage of 6850 kHz (green) with USCGC HEALY (red) and MAPLE (cyan).



# HF Digital Radio Mondiale (DRM) Broadcast Summary Report

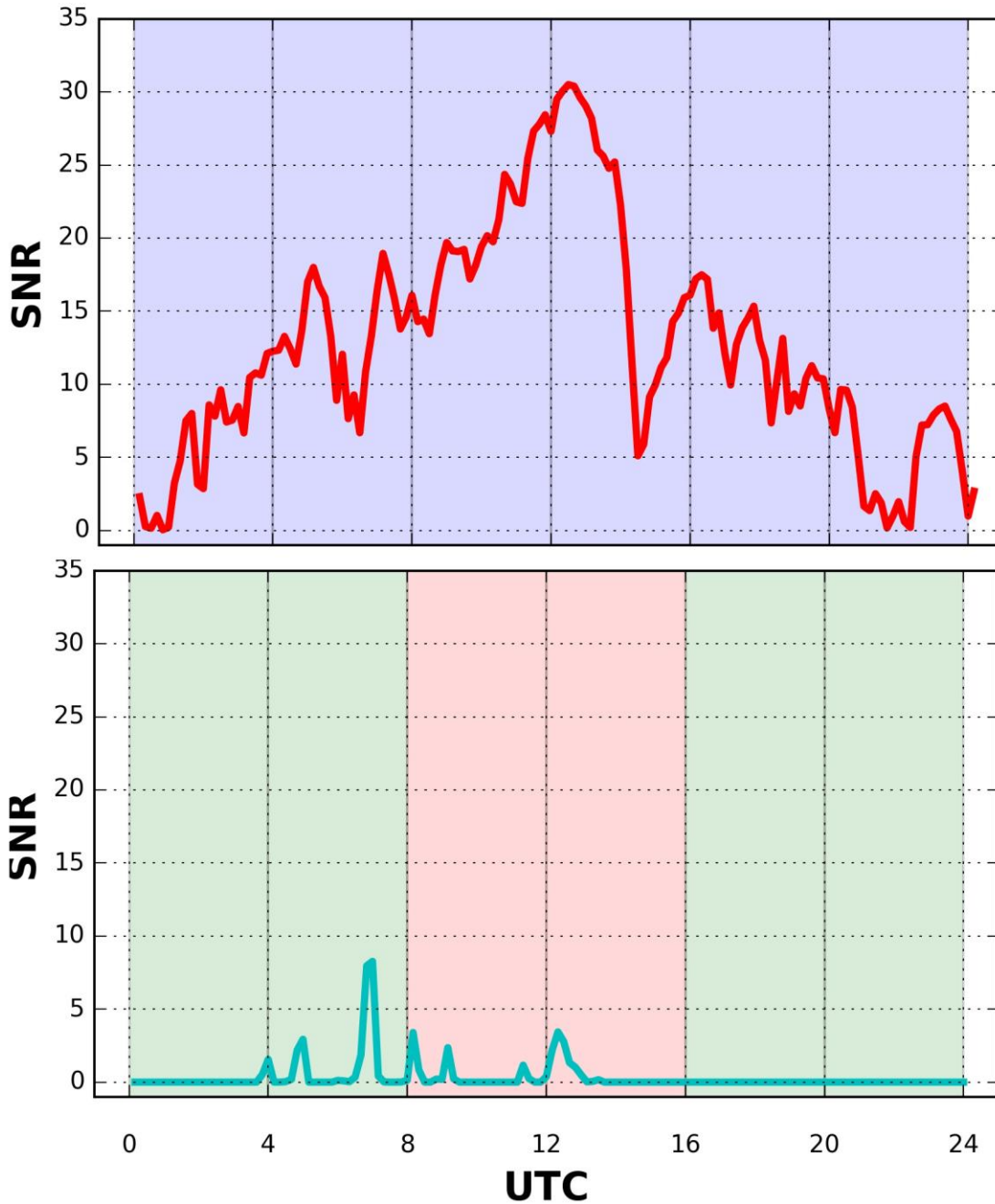

Figure 17. Jul 22, 2017 SNR at 6850 kHz as recorded on USCGC HEALY (data in red) receiving a ground wave (model only accounts for sky wave) and MAPLE (data in cyan).

In Figure 17, the HEALY receiver data more often than the forecast by Spectrum-E model. The RDC colored the plot with “blue” to mark the DRM Outperforming the model. However, the signal strength for Maple receiver, is either poorer than predicted (between 8 and 12 UTC), or matches the prediction (everywhere else). Green color indicates agreement of model and actual reception - it does not necessary show strong signal. Red marks the “DRM Underperforming” periods of time when model predicts a higher signal strength than actually was received.



# HF Digital Radio Mondiale (DRM) Broadcast Summary Report

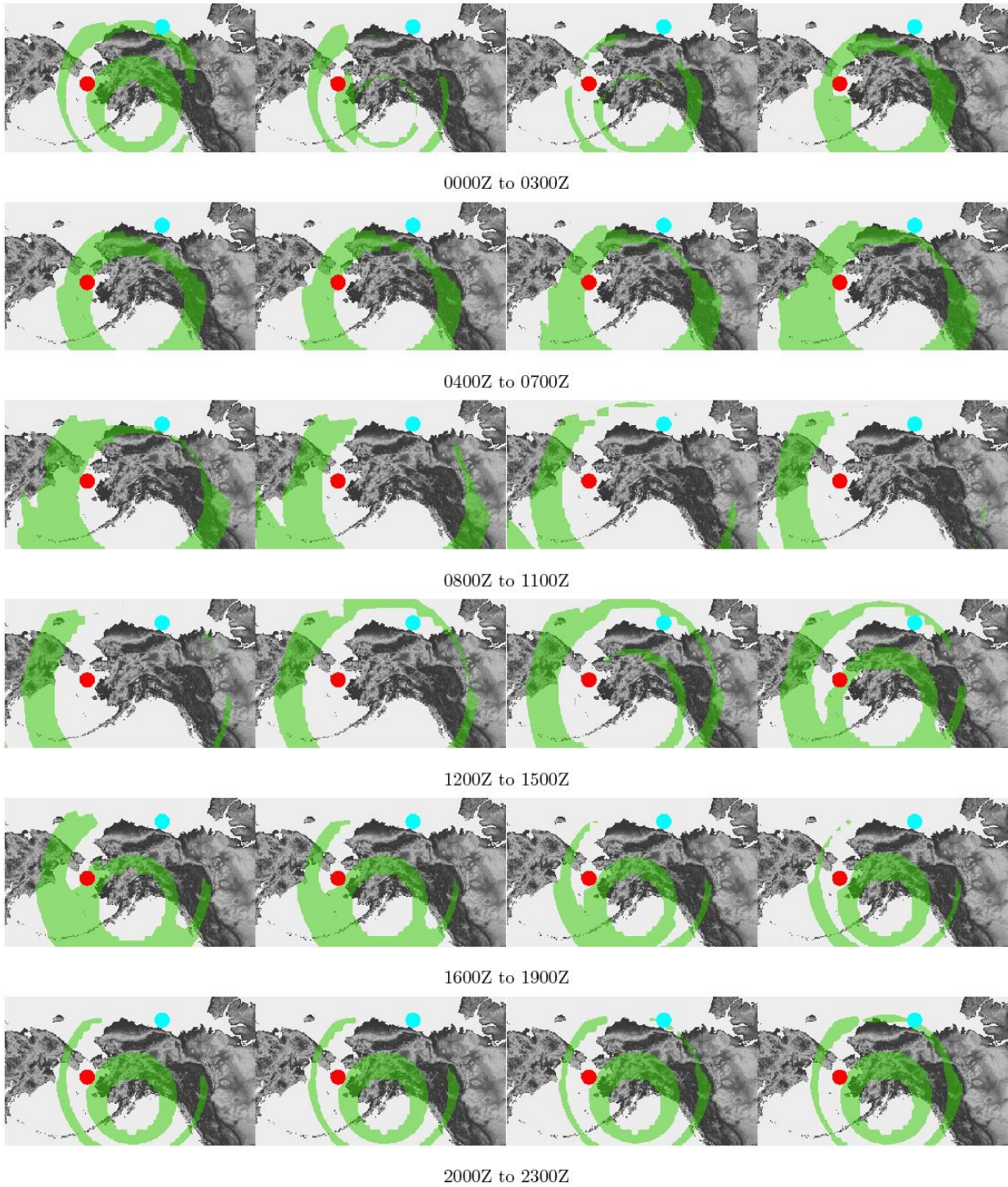

Figure 18. Jul 27, 2017 forecast coverage of 8000 kHz (green) with USCGC HEALY (red) and MAPLE (cyan).



# HF Digital Radio Mondiale (DRM) Broadcast Summary Report

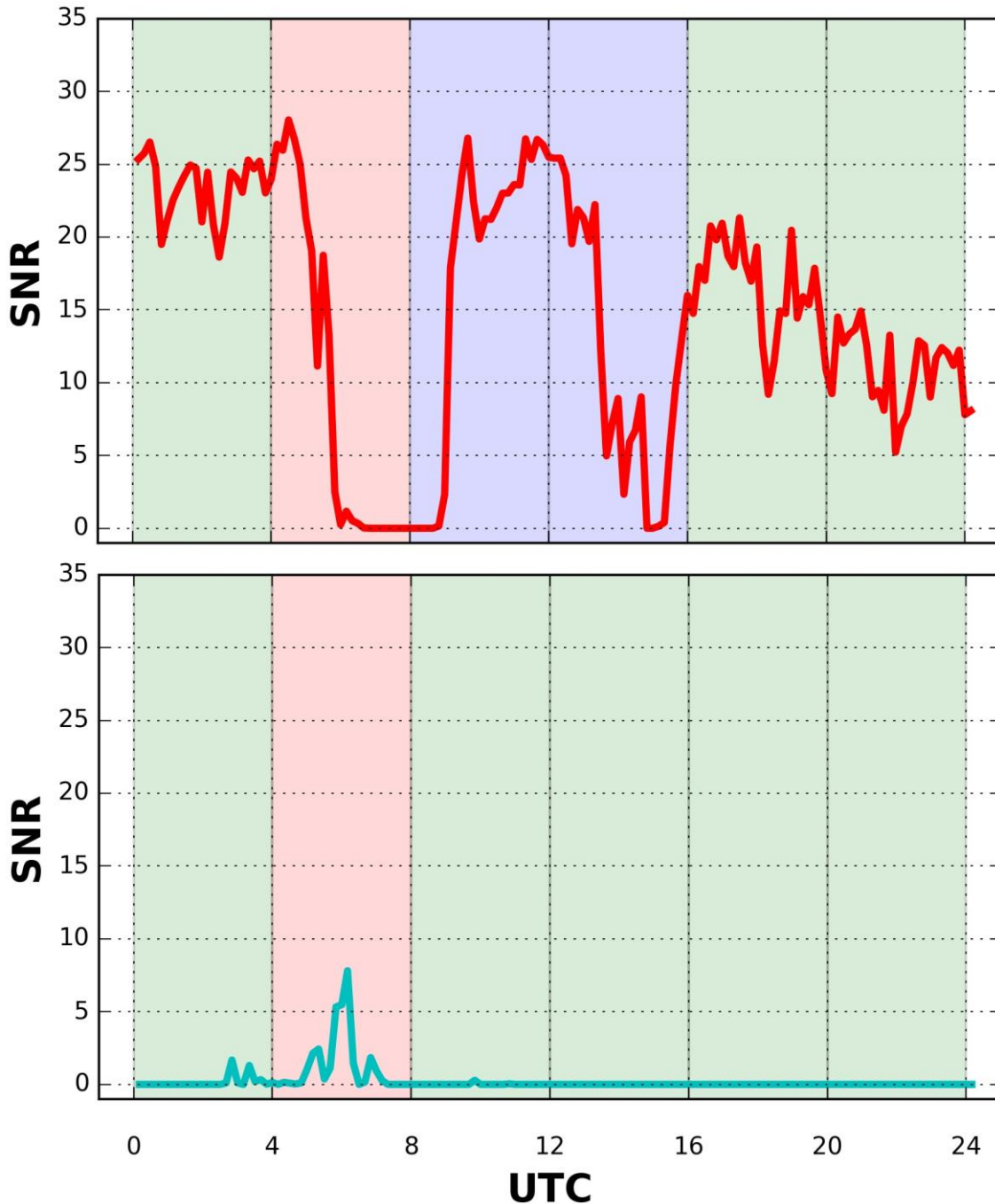

Figure 19. Jul 27, 2017 SNR at 8000 kHz as recorded on USCGC HEALY (red) and MAPLE (cyan).

Between 4 and 8 UTC in Figure 19, the model made an optimistic prediction of the reception of the signal on both cutters. The actual reception was lower; hence, the above plots are colored red for this DRM underperforming period. For HEALY, between 8 and 16 UTC, the prediction was too pessimistic, as the actual reception was stronger. This period for HEALY is colored blue to show the DRM outperforming the model. The rest of time for both cutters, the reception was as strong as expected. Green indicates the agreement of receiver reception and the model, even for periods of time where the reception is poor.



# HF Digital Radio Mondiale (DRM) Broadcast Summary Report

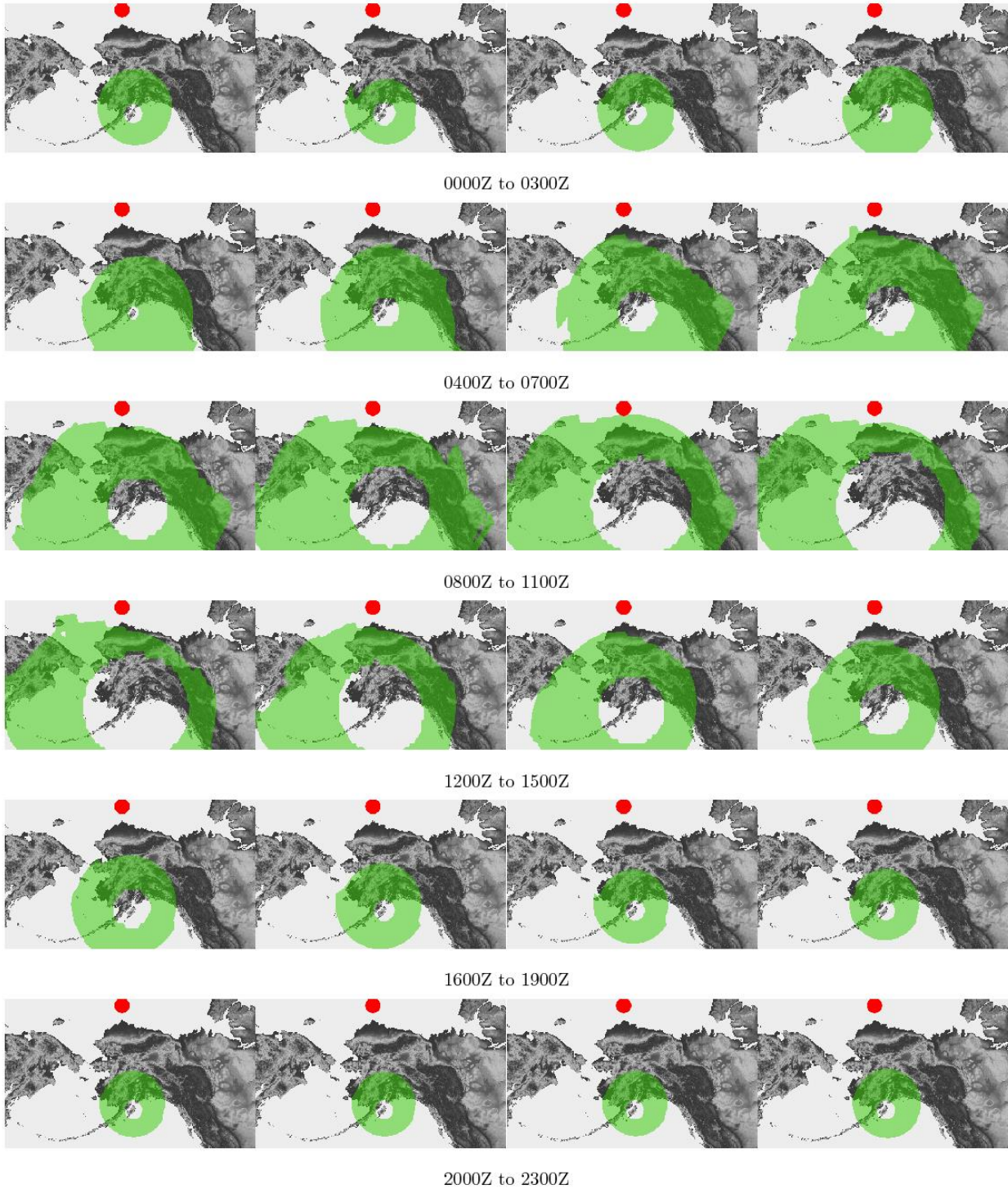

Figure 20. Aug 03, 2017, forecast coverage of 5200 kHz (green) with USCGC HEALY (red).



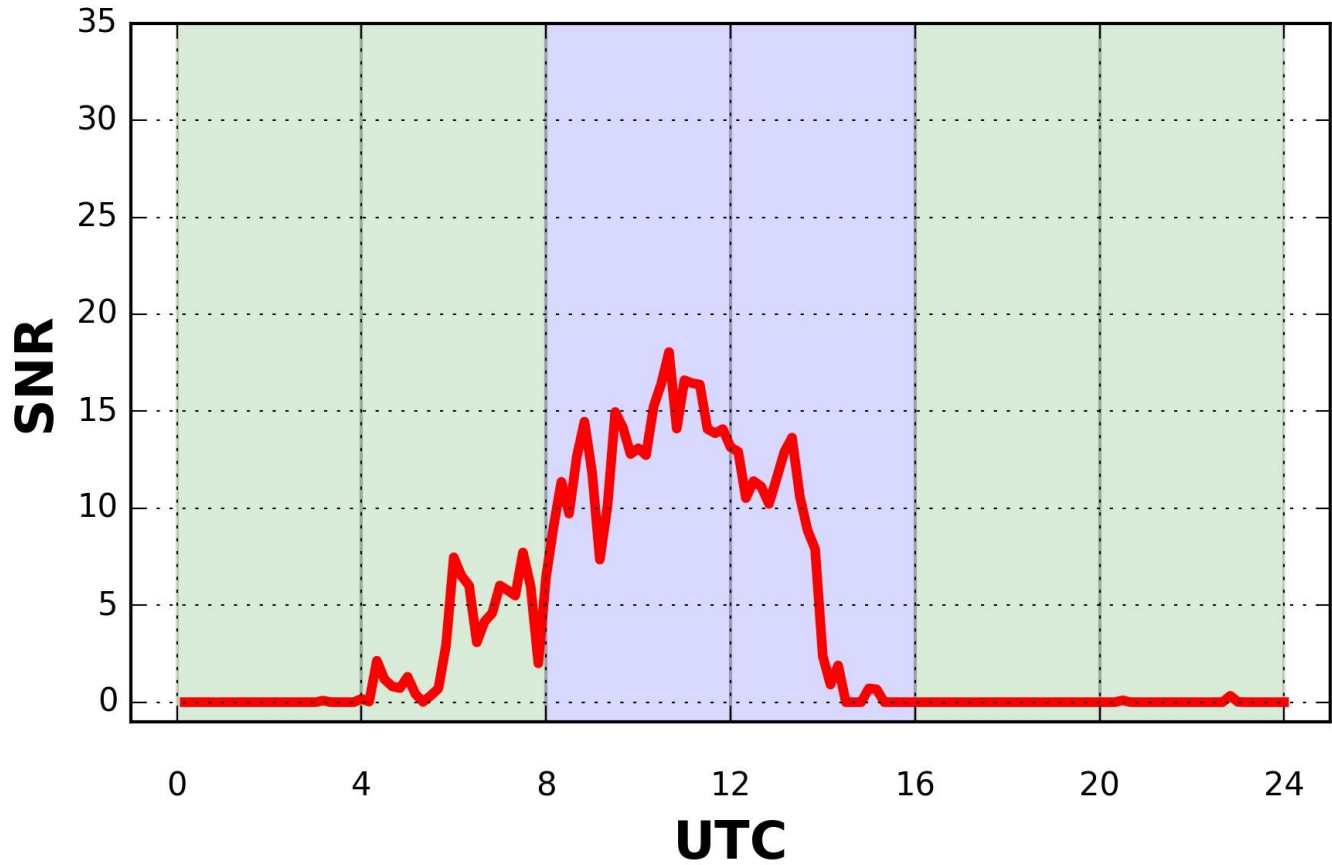

Figure 21. Aug 03, 2017 SNR at 5200 kHz as recorded on USCGC HEALY.

Between 8 and 16 UTC in Figure 21, the actual recorded reception was higher than the forecast by Spectrum-E, hence the DRM outperforming the model (marked as blue). At all other times, the reception was as expected.

## 6.2 Analysis Conclusion

As with any field test and data analysis, there is room for interpretation, and more data will help to build a stronger model. However, all things considered, this model appears to be very well supported by the field data. This model, therefore, will be used to make predictions to explore future build-out of the DRM system. Worst case sunspot numbers will be used instead of observed numbers

**This model, supported by actual field data, is the key that allows future cost / location / performance predictions to be made and forms the basis for future CONOPS.**

## 6.3 DRM Conclusion

HF DRM provides a cost-effective method of distribution of maritime and navigation safety information over long distances, including the Arctic. The DRM system has a modulation type that provides for reliable data delivery under HF skywave and ground wave. The content server provides a flexible and easy method of multiplexing data from different sources into a single data stream for modulation. The bit rate for each



# HF Digital Radio Mondiale (DRM) Broadcast Summary Report

data source can be specified individually thus giving priority to certain data types. The content server can access existing MSI sources such as NAVTEX and Weather data, making for an easy implementation.

## 7 NOTIONAL CONOPS

This section includes three, in-depth, notional Concepts of Operation (CONOPS) describing how the USCG may use the DRM system in Alaska, Hawaii, and the contiguous United States to provide electronic marine and navigation safety information to the mariner. It is clear from the results of this field test that frequency, transmitter power, and antenna type all play a role in DRM system design. This section presents coverage, cost, and performance specifications for the three coverage options shown below. All assumptions are based on the modeling that was introduced in the previous section. The earlier sections of this report provided a brief of the RDC’s field test and demonstrated how that test was used to verify the validity of the International Telecommunications Union (ITU) propagation model. That model will now be used to provide a forecast displaying the expected capabilities of the three notional DRM systems:

- Full Geographic Coverage Option;
- Full 24-Hour Coverage Option;
- Full Geographic and 24-Hour Coverage Option.

The model assumptions for each coverage option are in Table 4.

**Table 4. Model Assumptions for DRM Coverage Options**

Full Geographic Coverage Option	Full 24-Hour Coverage Option	Full Geographic and 24-Hour Coverage Option
A 15 dB SNR as empirically determined in the previous section.	same	same
The sunspot number will be set to 10 to reflect the worst-case situation.	same	same
Transmitter power to be adjusted as needed for the region (15 kW to 25 kW).	Use of existing USCG transmitters with 4 kW transmitter power	Transmitter power to be adjusted as needed for the region (15 kW to 25 kW).
Antenna type to be selected to provide best coverage for a particular region (Appendix E).	same	same
On a 20-minute schedule, the system will switch between broadcast frequencies (e.g., 2, 5, and 8 MHz).	Three transmitters on three different frequencies (e.g., 2, 5, and 8 MHz).	Three transmitters on three different frequencies (e.g., 2, 5, and 8 MHz).
DRM configured for robustness profile B (10 kHz bandwidth and 16-QAM constellation) resulting in 11,600 bits per second data rate. Data are repeated on each of the broadcast frequencies. In	DRM configured for robustness profile B (10 kHz bandwidth and 16-QAM constellation) resulting in 11,600 bits per second data rate. The same data are	DRM configured for robustness profile B (10 kHz bandwidth and 16-QAM constellation) resulting in 11,600 bits per second data rate. The same data are





# HF Digital Radio Mondiale (DRM) Broadcast Summary Report

theory, the resulting 20-minute frequency times lowers the effective data rate (for coverage purposes) to approximately 4000 bps. But in actuality, 11,600 bits per second are available for transmission in each 20 min. frequency broadcast.	repeated on each of the broadcast frequencies, simultaneously.	repeated on each of the broadcast frequencies, simultaneously.
--	--	--

## 7.1 Alaska DRM Forecast

### 7.1.1 Alaska Full Geographic Coverage Option

The stated objective of this project is to disseminate maritime and navigation safety information to the mariner transiting waters near Alaska. RDC conducted multiple propagation simulations to find a full-coverage solution. One solution that appears attractive is shown in Figure 22. A single transmitter installed in Fairbanks, AK, can provide coverage for the Gulf of Alaska, portions of the Aleutian Islands, as well as the North Slope up to the Pole.

This impressive coverage is driven by a single 25 kW transmitter coupled to a 62-foot TCI 550-4 antenna. This particular combination was chosen because the antenna is relatively small and easy to harden against the Arctic weather. For comparison, similar performance is obtained from a 15 kW transmitter and the TCI 540 antenna. Appendix E presents a brief description of each to allow the reader to understand the trade-offs between antennas, Arctic weather, and required transmitter power.

Users in the red-shaded area of Figure 22 can expect to receive the DRM's Journaline messages for 20 minutes in each hour. Recall that the propagation forecast is a composite of the 2, 4, and 8 MHz transmission where each frequency is used for 20 minutes. A user at any particular point on the chart is expected to receive only one of the frequencies. Users in the green and blue/purple may or may not reliably receive the transmissions. Summer is generally the worst time of the year for HF propagation due to the long daytime hours. The HF signal usually travels further in darkness. However, summer is the time of interest for Arctic transits, hence Figure 22 propagation model for August.



## HF Digital Radio Mondiale (DRM) Broadcast Summary Report

During the 20 minutes, Table 5 shows the data users can expect to receive.

Table 5. Proposed Alaska Data Broadcast (for 20 minutes)

Alaska Full Geographic Coverage Service Data Types	Average data size (in bytes)	# of files	Total Bytes
Weather Maps (Forecast) – Alaska	130,000	4	520,000
Weather Maps (Current) – Alaska	130,000	4	520,000
Ice Maps	200,000	2	400,000
Marine Forecasts from various sites	3,000	20	60,000
NAVTEXT Forecast (includes Alaska Coastal Waters Forecasts, Offshore Forecasts, High Seas Forecasts)	25,000	3	75,000
Marine Safety Information Bulletin	2,000	3	6,000
NOAA data buoy information	1,000	30	30,000
News and Sports	5,000	10	50,000
AIS ASM - Ice edge, NOAA buoy data, virtual ATONs, environmental	160	50	8,000
			1,669,000
Alaska Full Geographic Coverage Service Bit Rate (set by RDC)	11,600		
Alaska Full Geographic Coverage Service Time to Transmit (in minutes)	19		



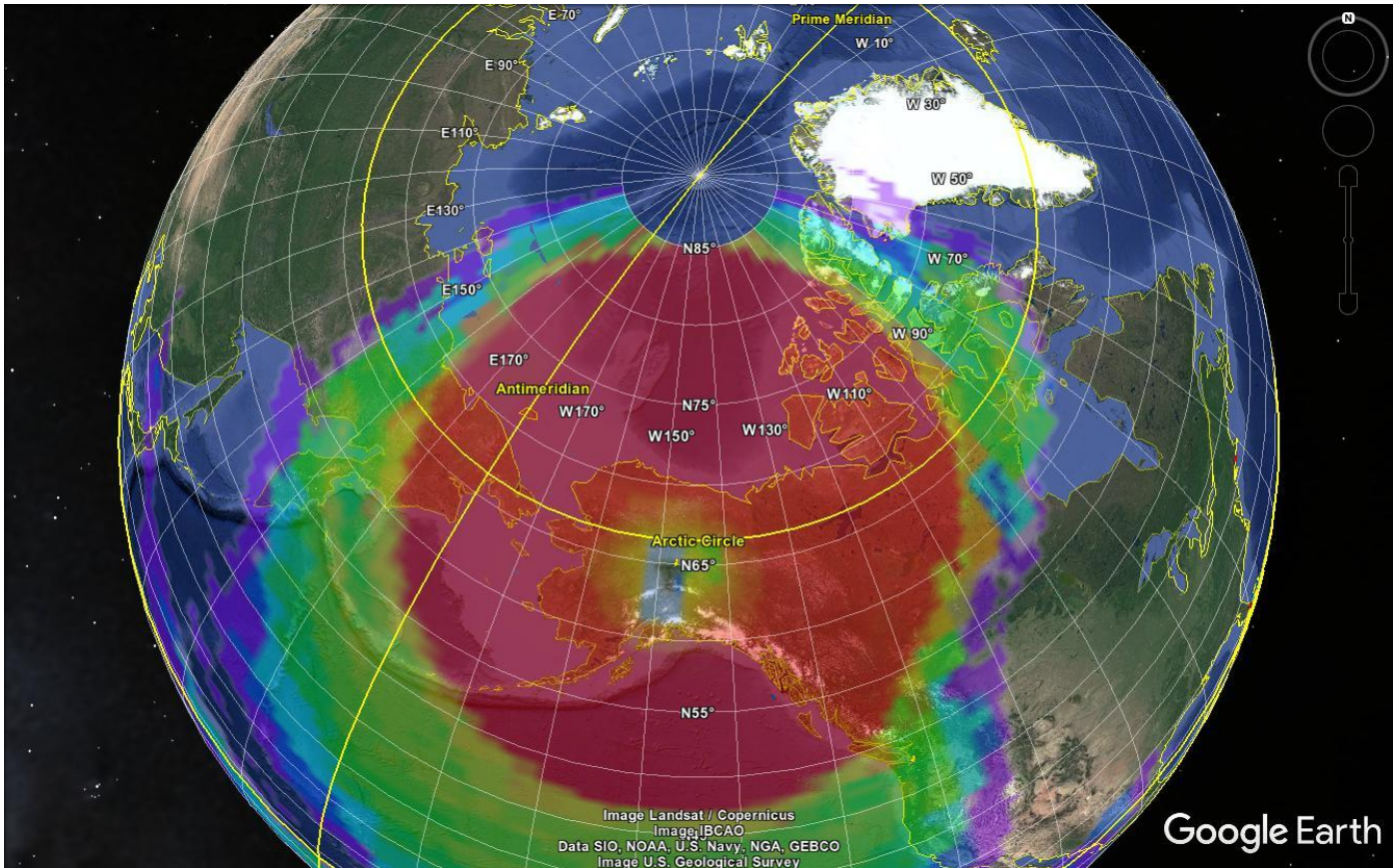

Figure 22. August propagation forecast for Fairbanks DRM transmission.

The Fairbanks installation has an order-of-magnitude cost estimate of \$500,000. This is composed of the following major components:

- \$150k for transmitter and switching network.
- \$100k for DRM modulation and computer equipment.
- \$40k for transmitting antenna.
- \$40k for backup generator.
- \$40k for “Conex” boxes to house the transmitting and backup generator equipment.
- \$30k for field monitors.
- 25% labor overhead cost (equal to \$100K).

Additional reoccurring costs are associated with periodic monitoring of the transmissions.

### 7.1.2 Alaska Full 24-Hour Coverage Option

The field test operated for over a year and proved that existing USCG HF transmitters can support DRM transmissions. This option would utilize the field test implementation, but instead of using one transmitter and rotating through the three best frequencies (2, 5, and 8 MHz), three simultaneous transmissions (simulcast) would be implemented. In this case, a single content server would provide the same broadcast



## HF Digital Radio Mondiale (DRM) Broadcast Summary Report

data stream to three modulators; each modulator would be assigned a different frequency, transmitter/amplifier, and antenna. For Alaska, existing transmitters and antennas at Kodiak would provide the geographic coverage shown in Figure 23.

Users in the red-shaded area of Figure 23 can expect to receive the DRM's File, Journaline and AIS messages at a data rate of approximately 11,600 bps, which is similar to the data rate experienced during the field test. This means all the data provided during the field test and discussed in Table 5 would be broadcast to the mariner. As research is performed to determine the best mix of marine and navigation safety information to be broadcast, the mix of data can be adjusted.

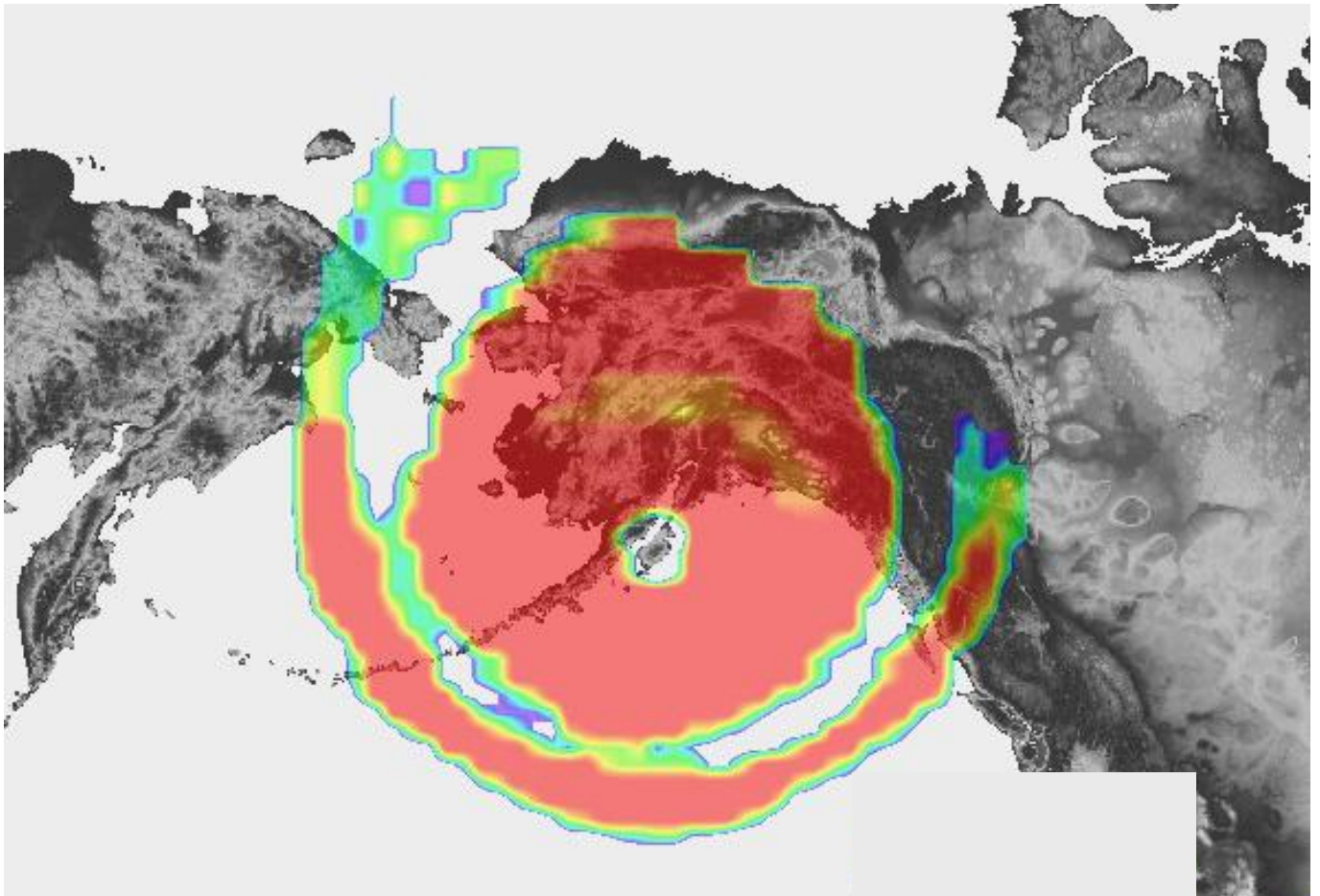

Figure 23. August propagation forecast for 24-hour Kodiak DRM transmission (existing infrastructure).

This Full 24-Hour Coverage Option has an order-of-magnitude cost of \$240,000. This is composed of the following major components.

- \$160k for DRM modulation and computer equipment (\$100k for first system, and an additional 30k each for two additional modulators).
- \$30k for field monitors.
- 25% labor overhead cost (equal to \$50K).



### 7.1.3 Alaska Full Geographic and 24-Hour Coverage

This option is a combination of Options 1 and 2, full geographic coverage and full 24-hour coverage. Three 25 kW transmitters coupled with three 62-foot TCI 550-4 antennas at Fairbanks, AK would provide users in the red shaded area of Figure 22 with full, 24-hour coverage. The expected data rate would be similar to that received during the field test, approximately 11,600 bps.

This full geographic and 24-hour coverage option has an order-of-magnitude cost estimate of \$1,060,000. This is composed of the following major components:

- \$450 for three transmitters (\$150k for each transmitter and switching network).
- \$160k for DRM modulation and computer equipment (\$100k for first system and then an additional 30k each for two modulators).
- \$120k for antennas (\$40k for each of three transmitting antennas).
- \$50k for backup generator.
- \$50k for “Conex” boxes to house the transmitting and backup generator equipment.
- \$30k for field monitors.
- 25% labor overhead cost (equal to \$200K).

## 7.2 Expanded DRM Coverage

The DRM system may be expanded to cover the contiguous United States and Hawaii. This expanded coverage is desirable as it extends the range of traditional MSI broadcasts such as NAVTEX. It is also desirable as greater use is certain to lower the cost and improve availability of end-user equipment. Greater use should also expand the value and functionality of the accompanying software applications.

### 7.2.1 Full Geographic Coverage Option

With five transmitters, the DRM system could provide coverage to the Western Rivers, Great Lakes, East Coast, West Coast, Alaska, and Hawaii as shown in Figure 24.



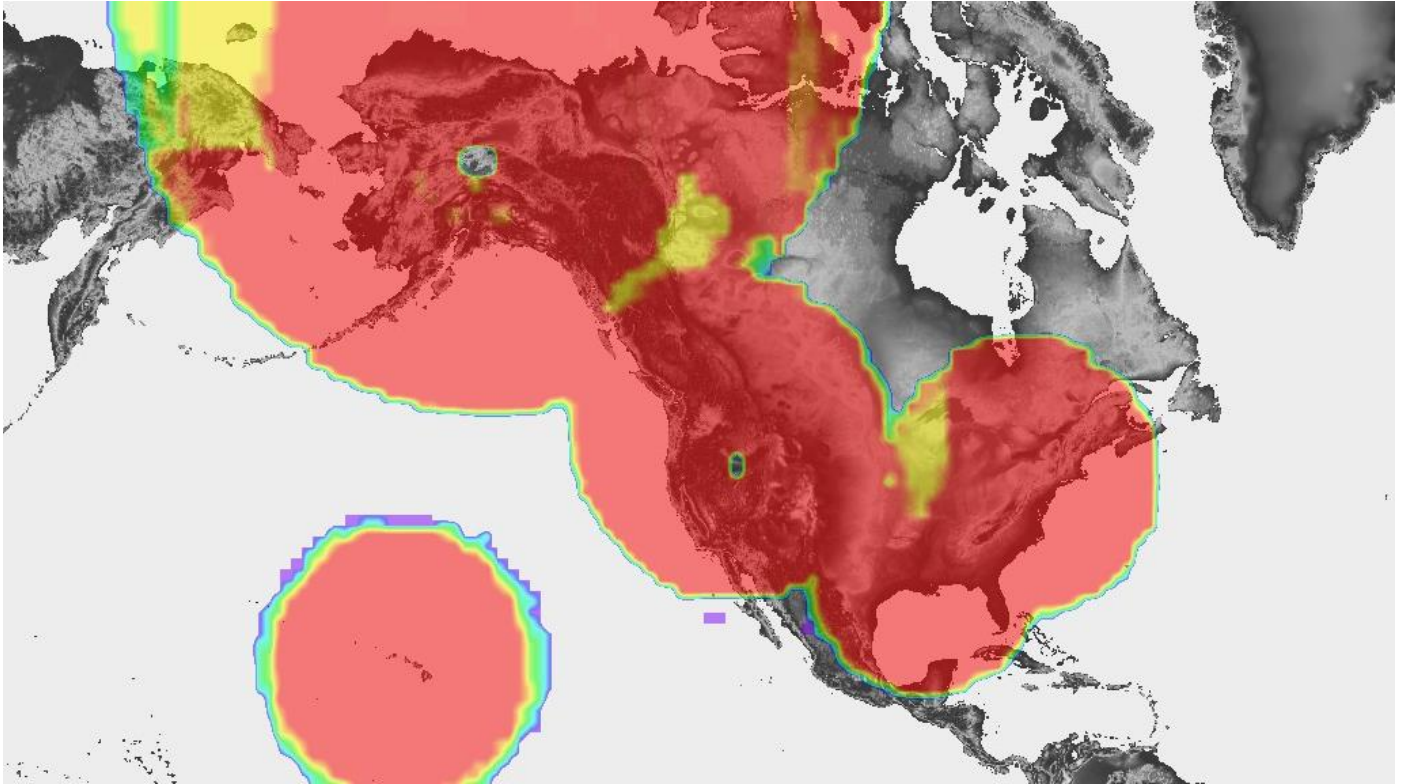

Figure 24. August propagation forecast Full Geographic Coverage Option.

Table 6 lists the requisite transmitter locations and powers, along with the antenna types. These transmitter site locations were chosen to minimize the total number of required transmitters while maximizing coverage. The low-cost TCI-550-4 antenna was used whenever possible. Unfortunately, this antenna could not be used at all locations as it leaves an unacceptable skip zone (donut hole) in the immediate vicinity of the transmitter.

The total cost for each transmitter is slightly less than that previously mentioned for the Fairbanks facility, approximately \$400,000 per site.

Table 6. Potential DRM locations to provide nationwide geographic coverage.

Location	Power	Antenna Type
Fairbanks, AK	25,000 W	TCI-550-4
Honolulu, HI	15,000 W	TCI-530
Twin Falls, ID	15,000 W	TCI-550-4
New Orleans, LA	5,000 W	TCI-530
Harrisburg, PA	15,000 W	TCI-530

**7.2.2 Full 24-Hour Coverage Option**

As with the Full Geographic Coverage Option, the Full 24-hour Coverage Option would attempt to cover the entire United States. As with the Alaska coverage, there are gaps in the geographic coverage as shown in Figure 25. The most significant feature of this option is that it incorporates existing USCG facilities with



# HF Digital Radio Mondiale (DRM) Broadcast Summary Report

HF transmitters and antennas to provide a simulcast solution on three frequencies without constructing new transmitter sites.

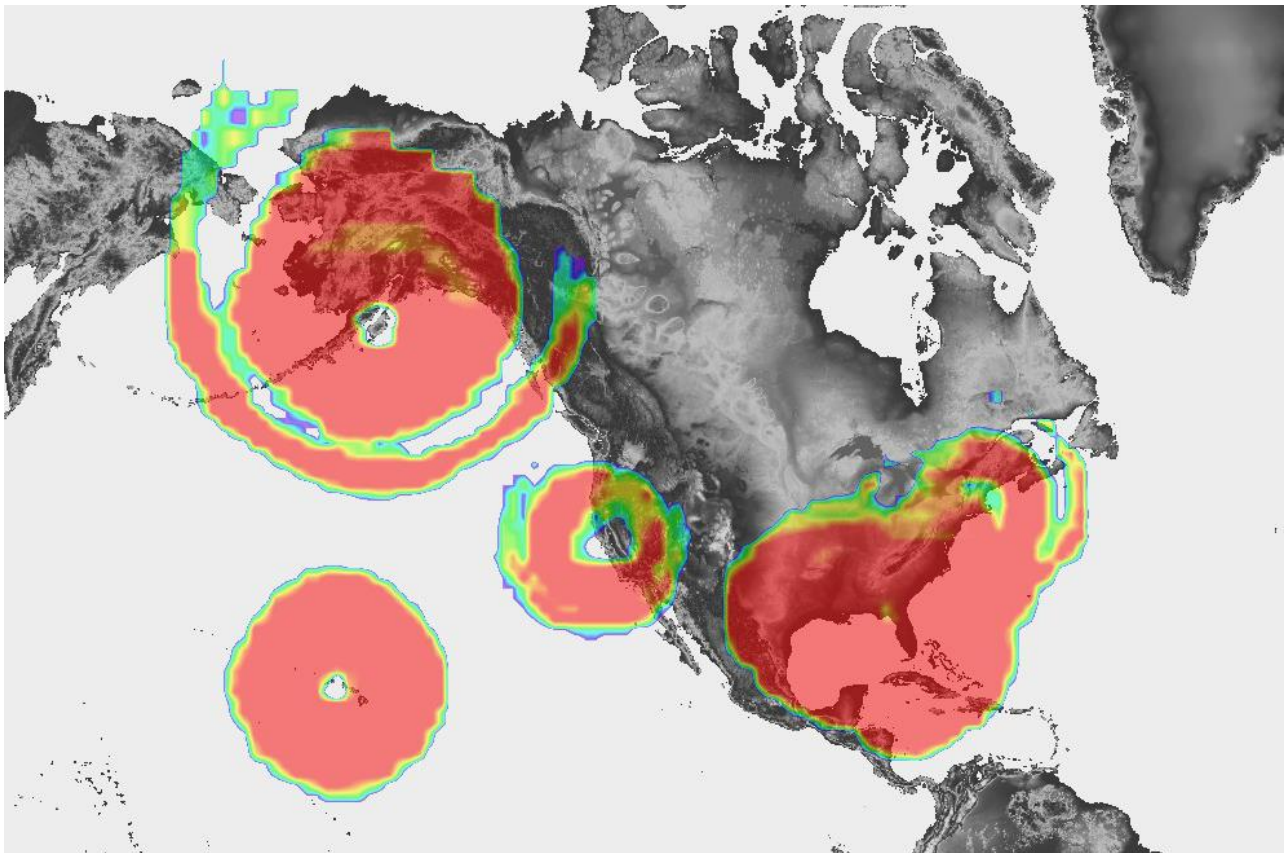

Figure 25. August propagation forecast for Full 24-hour Coverage Option.

Table 7 lists the existing USCG transmitter location (4 kW each) and antenna types.

**Table 7. Table for Full 24-Hour DRM Coverage Option**

Location (Call Sign)	Antenna Type
CAMSLANT (NMN) Virginia Beach	TCI 550-4, TCI 550-4 and TCI 530-3
Boston (NMF)	TCI 530-3, TCI 530-5 and TCI 550-3
New Orleans (NMG)	TCI 550- 4, TCI 550-3 and TCI 530-3
Miami (NMA)	TCI 540-2, TCI 540-2 and TCI 540-1
CAMSPAC (NMC) San Francisco	Three each of TCI 550-4
Honolulu (NMO)	TCI 540-2, TCI 540-2 and TCI 550-3
Kodiak (NOJ)	TCI 550-4, TCI 540-1 and TCI 530-3

Cost would be similar to Kodiak (\$240,000 per site).



### 7.2.3 Full Geographic and 24-Hour Coverage Option

This option combines the strong features of the previous two options. It attains full geographic coverage by using high power transmitters in Fairbanks, AK, Honolulu, HI, Twin Falls, ID, New Orleans, LA and Harrisburg, PA and full 24-hour coverage by simulcasting on all three frequencies. This option would provide users in the red-shaded area of Figure 22 with full, 24-hour coverage. The expected data rate would be similar to that received during the field test, approximately 11,600 bps.

This full geographic and 24-hour coverage option installation has an order-of-magnitude cost estimate of \$1,000,000. This is composed of the following major components:

- Transmitters- \$390k for average cost of three 15-25kW transmitters (\$130k each)
- \$160k for DRM modulation and computer equipment (\$100k for first system and then an additional 30k each for two modulators).
- \$120k for antennas (\$40k for each of three transmitting antennas).
- \$50k for backup generator.
- \$50k for “Conex” boxes to house the transmitting and backup generator equipment.
- \$30k for field monitors.
- 25% labor overhead cost (equal to \$200K).

### 7.3 System Capability and Cost

To properly frame the future capabilities of the DRM system, it is necessary to characterize the broadcast content. Like a computer connected to the internet, DRM is constrained by the rate that information can be received. Based on the discussion in the previous sections, DRM’s data rate is 11,600 bps, a rate afforded by DRM operating in robustness mode B with a QAM-16 modulation.

A DRM equipped mariner can expect to receive four general types of data, including pictures, graphics, human-readable text, and compact binary encoded data. Examples of images important to the mariner are included as Figure 26 through Figure 28.

The High Seas Forecast in Figure 28 is an example of a large human-readable text message. The AIS virtual ATON (AIS message 21) is an example of a compact binary-encoded (non-human-readable) message. The AIS messages are encoded using a base-64 format consisting of printable numbers, upper case plus lowercase letters, and a few symbols.

Each item to be sent, hereafter called a document, has a particular size. Image documents are the largest items to be broadcast over DRM. Section 3.1.1 - Table 1, Table 2 and Table 3 - describe the types of documents transmitted during the field test. For discussion purposes, example data will be presented in this section as well. When the bandwidth limitation is reached, a means to reduce files sizes is vital. The wind and wave forecast in color (Figure 26) consumes 150 kB compared to 80 kB in black and white (Figure 27). Reduction in resolution of image documents may also help reduce bandwidth consumption. The time it takes the color image of 150 kB to transmit is 1.7 min. (Figure 26) compared to the black and white image of 80kB which would take 0.9 min. in Figure 27. Text documents may not contain as much information (small size): the high seas forecast shown in Figure 28 would consume about 3.7 seconds. The 360-bit virtual ATON document could be sent in a fraction of a second.





# HF Digital Radio Mondiale (DRM) Broadcast Summary Report

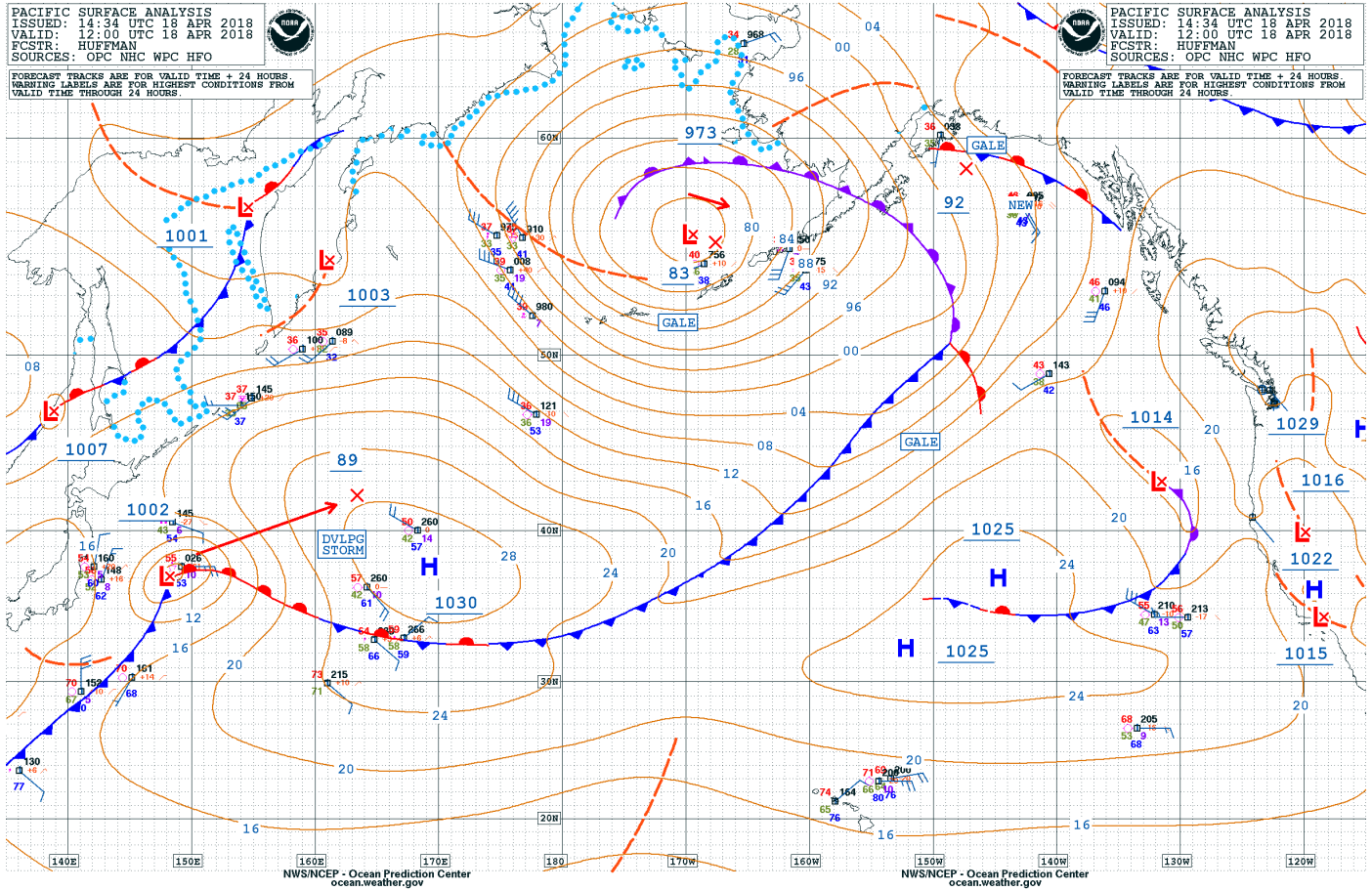

Figure 26. This 150 kB wind and wave forecast takes 1.7 minutes to transmit.



# HF Digital Radio Mondiale (DRM) Broadcast Summary Report

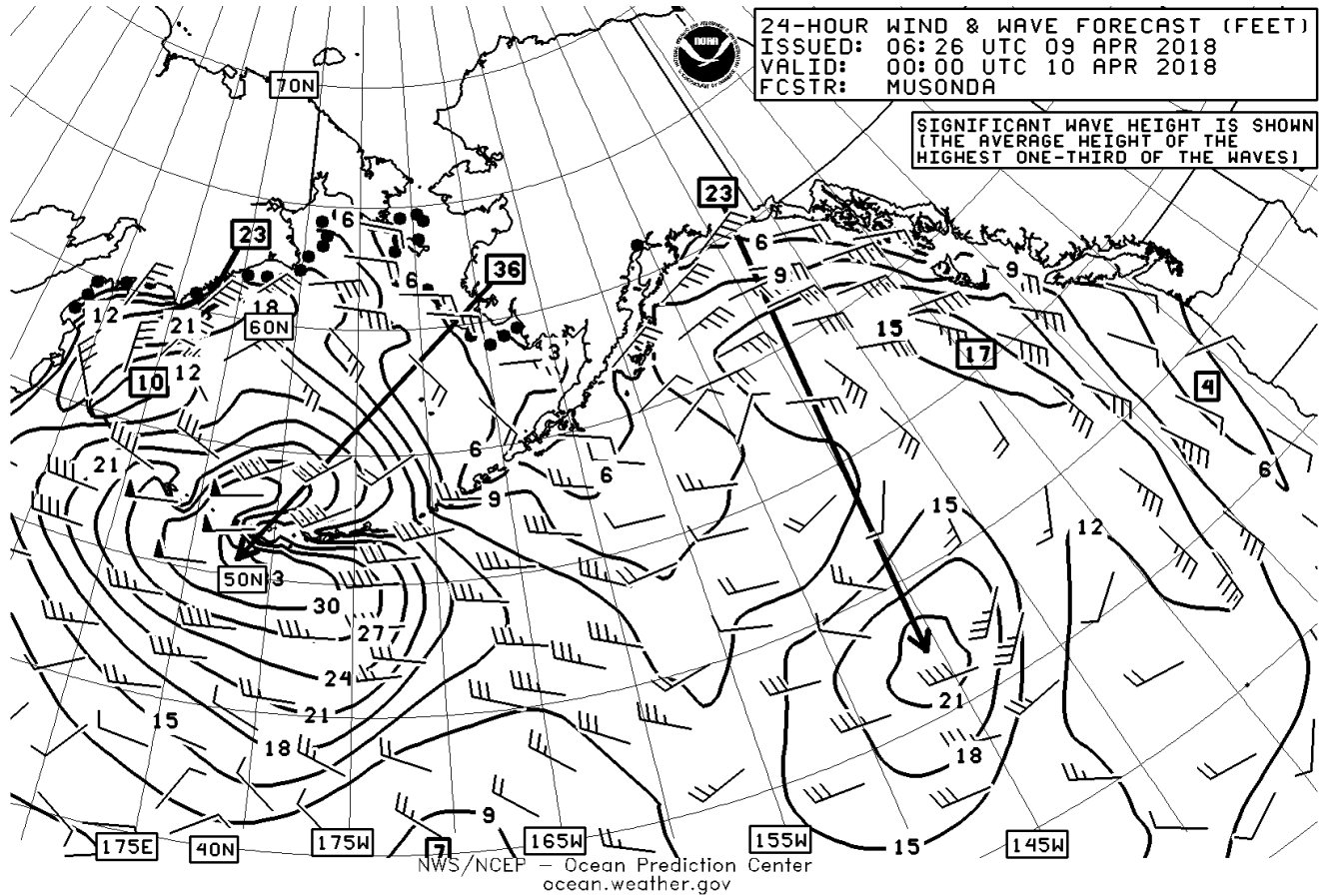

Figure 27. This 80 kB wind and wave forecast takes 0.9 minutes (54 seconds) to transmit.



## HF Digital Radio Mondiale (DRM) Broadcast Summary Report

FZPN01 KWBC 090932  
HSFEP1

HIGH SEAS FORECAST  
NWS OCEAN PREDICTION CENTER WASHINGTON DC  
1030 UTC MON APR 09 2018

SUPERSEDED BY NEXT ISSUANCE IN 6 HOURS

SEAS GIVEN AS SIGNIFICANT WAVE HEIGHT...WHICH IS THE AVERAGE HEIGHT OF THE HIGHEST 1/3 OF THE WAVES. INDIVIDUAL WAVES MAY BE MORE THAN TWICE THE SIGNIFICANT WAVE HEIGHT.

SEE ANNOUNCEMENT OF PLANNED INMARSAT I-3 TO I-4 MIGRATION IN 2018 AT [OCEAN.WEATHER.GOV/GMDSS\\_NOTICE.PHP](http://OCEAN.WEATHER.GOV/GMDSS_NOTICE.PHP) (LOWERCASE) .

ONLY YOU KNOW THE WEATHER AT YOUR POSITION. REPORT IT TO THE NATIONAL WEATHER SERVICE. EMAIL US AT [VOSOPS@NOAA.GOV](mailto:VOSOPS@NOAA.GOV) (LOWERCASE) .

PAN PAN

PACIFIC N OF 30N AND S OF 67N E OF A LINE FROM BERING STRAIT TO 50N 160E

SYNOPSIS VALID 0600 UTC APR 09.  
24 HOUR FORECAST VALID 0600 UTC APR 10.  
48 HOUR FORECAST VALID 0600 UTC APR 11.

.WARNINGS.

...HURRICANE FORCE WIND WARNING...

.24 HOUR FORECAST NEW LOW 46N160E 997 MB. OVER FORECAST WATERS WITHIN 420 NM SE QUADRANT WINDS 25 TO 35 KT. SEAS TO 12 FT.  
.30 HOUR FORECAST LOW 47N163E 998 MB. FROM 42N TO 47N W OF 163E WINDS 40 TO 50 KT. SEAS 12 TO 20 FT.  
.48 HOUR FORECAST LOW 48N173E 976 MB. BETWEEN 120 NM AND 300 NM SW SEMICIRCLE WINDS 50 TO 65 KT. SEAS 20 TO 40 FT. ELSEWHERE BETWEEN 90 NM AND 420 NM SW SEMICIRCLE WINDS 40 TO 50 KT. SEAS 18 TO 30 FT. ALSO WITHIN 360 NM NE...900 NM SE...AND 540 NM SW AND W QUADRANTS WINDS 25 TO 40 KT. SEAS 11 TO 22 FT.

Figure 28. A 5.2 kB High Seas Forecast (partial shown) takes about 3.7 seconds to transmit.

Considerable research remains to determine the appropriate mix of material to broadcast. The mariner's needs must be better understood.



## HF Digital Radio Mondiale (DRM) Broadcast Summary Report

Table 8 summarizes the rough order of magnitude cost associated with each of the three options presented in Section 7 - NOTIONAL CONOPS.

Table 8. Notional CONOPS cost and limitations of each option presented.

	<b>Full Geographic Coverage</b> <i>LIMITATION - gaps in times of coverage</i>	<b>Full 24-Hour Coverage</b> <i>LIMITATION - gaps in geographic coverage</i>	<b>Full Geographic and Full 24-Hour Coverage</b>
<b>Cost for Alaska only</b>	\$500,000	\$240,000	\$1,060,000
<b>Cost for Continental United States, Hawaii and Alaska</b>	\$2,100,000 (\$500,000 + (\$400,000 x 4 sites))	\$1,680,000 (\$240,000 x 7 sites)	\$5,060,000 (\$1,060,000 + (\$1,000,000 x 4 sites))

## 8 RECOMMENDATIONS FOR FUTURE WORK

HF DRM can provide a cost-effective method of distribution for eMSI over long distances, such as in the Arctic. The DRM system has a modulation type that provides for reliable data delivery under challenging data transmission conditions such as HF skywave. The content server provides a flexible and easy method of multiplexing data from different sources into a single data stream for modulation. The bit rate for each data source can be specified individually, thus giving priority to certain data types. The content server can access existing MSI sources, such as NAVTEX and Weather data, making for an easy implementation and transition.

The primary issue to be resolved is coverage. Due to the fluctuations in the ionosphere and changing propagation conditions, the best HF-spectrum frequency to use is not constant: it varies with time and position. Therefore, the best way to establish reliable broadcast coverage is to transmit the same information using multiple frequencies. A single content server can send the same broadcast data stream to multiple modulators; each modulator can be assigned a different frequency, amplifier, and antenna. The receivers can scan the pool of frequencies automatically and lock on to the strongest one for reception of the broadcast where the receiver is located.

The following topics are recommendations for additional work to improve USCG understanding and concepts for implementation of DRM.

### Mariner Needs

The mariner needs for electronic maritime and navigation safety information is unclear. The RDC project team made educated guesses on the interval and type of data the mariner most needed. Many questions are yet to be answered: what information, what level of resolution, how often, what should it look like (portrayal), and where the information should be presented to the mariner (e.g. ECS, separate device, mix of



## **HF Digital Radio Mondiale (DRM) Broadcast Summary Report**

---

both). The RDC recommends that the USCG and the U.S. Committee on the Marine Transportation System (CMTS) collaborate to develop a better understanding of the mariner needs for electronic maritime and navigation safety information that will answer those questions and move timely, electronic and effective marine safety information to the mariner.

### **Collaborate with NOAA**

USCG has a long history of extensive partnership with NOAA, which ranges from safe navigation to oil spill response. The RDC recommends partnering with NOAA to develop and produce a customized Journaline service for the benefit of mariners. Such customized Journaline could augment the following feeds from the agencies: notifications of ice edge information from the National Ice Center and icebergs from USCG International Ice Patrol; or integrating weather maps from NOAA with the Coast Guard's mariner alerts for safe sailing. Periodic meetings between the two agencies to share and review lessons learned will lead to increased maritime awareness and the safety of commercial and recreational mariners.

### **International Partnerships**

Since the DRM's introduction, the standard has received regulatory and technical support from transnational and international organizations such as the DRM consortium, ITU, and ETSI. Similar to the existing, close collaborations with partner nations through IMO, RDC recommends that USCG share its DRM experiences and results, lessons learned, and technical innovations with these organizations. In addition, having compatible standards across nations facilitates Search and Rescue operations, and responding to natural disasters that are not limited to geopolitical boundaries. The USCG and CMTS can influence standard development and work with the international maritime community to enhance navigation safety worldwide. RDC also recommends that USCG work with the International Maritime Organization (IMO) and the Global Maritime Distress and Safety System (GMDSS) standards committees to identify suitable DRM equipment and procedures for the dissemination of Marine Safety Information (MSI) to shipboard mariners.

### **DRM Implications**

One of the key lessons learned from this project is that the use of DRM is not limited to the Arctic or other areas with inadequate telecommunications infrastructure. Therefore, considering the Coast Guard's large footprint on the East Coast, and the long list of historical hurricanes in the region, DRM coverage of the area would provide crucial benefits for future operations of the Coast Guard and to commercial and recreational sailors. RDC recommends establishing a pilot DRM service at Boston (Cape Cod), MA, this would augment the existing telecommunications infrastructure, and greatly enhance the critical communications needed to respond to natural disasters and search and rescue operations in this region. This pilot DRM service will also assist USCG Communications Command (COMMCOM) develop a better understanding of transmitter power and locations for use of DRM.

### **DRM Transmitters/Locations/Antennas/Receivers (Trade Space)**

The RDC recommends the USCG RDC research and develop an ideal model for COMMCOM to calculate the parameters and architecture for a powerful transmission, not only to provide enough bandwidth for required transmission, but also to tailor the locations to utilize USCG-owned HF antennas to the maximum extent possible. Several factors influence the total cost of installing DRM systems. First, efficiently choosing the number of transmitters, itself a function of the model's efficiency, has a direct impact on the total cost. An efficient model will minimize the number of the transmitters while maintaining a satisfactory



## HF Digital Radio Mondiale (DRM) Broadcast Summary Report

---

DRM coverage. Second, utilizing existing USCG assets, such as antennas and generators, will reduce the total cost of the installation. However, the Coast Guard's infrastructure is not evenly distributed across its area of responsibility (AOR), and the availability of any equipment that could be spared for DRM installations varies among the USCG bases, sectors, and stations. Another factor to consider is the location of the USCG assets, and whether a given asset is at an appropriate location to boost DRM coverage. For example, as previously mentioned, Table 6 describes the potential DRM locations to provide nationwide geographic coverage. Since there are no USCG-owned antennas in those locations, the installation team will incur additional costs for procuring COTS antennas, labor, and travel expenses. Third, there is always a trade-off between the cost and performance of any system. A higher-end DRM transmitter will feature superior performance but will cost more than lower-end equipment. An ideal model will predict not only the performance of the DRM broadcast, but also the costs, and recommendations for combining COTS and USCG-owned assets to reach a specific trade-off between the two criteria.

The availability of DRM receivers is growing rapidly in the market. The implications of this quick growth needs investigation. RDC recommends partnering with the USCG Academy (USCGA) to perform market research to investigate the capabilities and limitations of commercial-off-the-shelf (COTS) DRM receivers.

### Contingency Communications

Even if a maritime or shore-side region already enjoys a satisfactory satellite communication and RF coverage, by delivering high quality, flexible communications, DRM would be a powerful communication contingency for a large area of coverage. RDC recommends that COMMCOM take the lead in developing such a contingency plan for DRM communications. According to High Frequency Coordination Conference (HFCC)<sup>1</sup> "In specific context situations, such as natural disasters, periods of social unrest, electricity blackouts, deliberate communication shut-downs, or in developing regions, there is no other equally effective alternative to radio distribution." Among radio standards, no other standard can outperform DRM in terms of quality, flexibility and dynamism of the content, area coverage, and frequency spectrum.

### Cyber Security

Both AIS ASM and Journaline data are susceptible to a variety of cyber-attacks. Since all the Journaline data (e.g., Google News RSS feeds) originates from the Internet, their security could be compromised by the same cyber threats faced by other users, such as banks, factories, Government agencies, ports, and individual Internet users. Ensuring all the cyber defense measures, such as network traffic monitoring, installing intrusion detection systems, and encryption of the AIS ASM and Journaline feeds on the network on which fetching and formatting the data take place, are essential for protecting the integrity of the broadcast MSI and other information. RDC recommends partnering with CG-Cyber and CG-791 to provide expertise to research suitable cyber security measures for the DRM transmission system.

---

<sup>1</sup> [http://www.hfcc.org/delivery/HFCC-IBD\\_DRM.phtml](http://www.hfcc.org/delivery/HFCC-IBD_DRM.phtml)



## 9 REFERENCES

- [1] DRM Consortium “The DRM Digital Broadcasting System Introduction and Implementation Guide,” DRM Consortium, Geneva, Switzerland. Revision 2, 13 September 2013.
- [2] European Telecommunications Standards Institute, “Digital Radio Mondiale (DRM); System Specification,” European Telecommunications Standards Institute (ETSI) ETSI ES 201 980 V4.1.1, January 2014.
- [3] European Telecommunications Standards Institute, “Digital Radio Mondiale (DRM); Data Applications Directory,” European Telecommunications Standards Institute (ETSI) ETSI TS 1101 968 v1.2.1, October 2004.
- [4] European Telecommunications Standards Institute, “Digital Audio Broadcasting (DAB); Journaline; User application specification,” European Telecommunications Standards Institute (ETSI) ETSI TS 102 979 V1.1.1, June 2008.
- [5] G. W. Johnson and B. Tetreault, “Identification of Standards Needed to Support Robust and Reliable AIS Transmit Operations,” in European Navigation Conference ENC 2016, Helsinki, Finland, 2016.
- [6] G. W. Johnson, M. Winkler, and B. Tetreault, “Dissemination of enhanced Marine Safety Information (eMSI) via AIS,” in Radio Technical Commission for Maritime Services Annual Conference, St Petersburg, FL, 2016.
- [7] G. W. Johnson, B. J. Tetreault, and I. M. Gonin, “Development of an AIS Transmit Architecture to support the dissemination of electronic Marine Safety Information (eMSI),” presented at the European Navigation Conference (ENC14), Rotterdam, 2014.
- [8] International Maritime Organization, “IMO/WMO Worldwide Met-ocean Information and Warning Service – Guidance Document,” IMO, London, UK, Resolution A.1051(27), 20 December 2011.
- [9] International Maritime Organization, “Amendments to Resolution A.705(17) – Promulgation of Maritime Safety Information,” IMO, London, UK, MSC.1/Circ. 1287/Rev.1, 24 June 2013.
- [10] International Maritime Organization, “Revised Joint IMO/IHO/WMO Manual on Maritime Safety Information (MSI),” IMO, London, UK, MSC.1/Circ. 1310/Rev. 1, 21 November 2014.
- [11] I. M. Gonin and G. W. Johnson, “RDC Review/Status of IMO MSI Systems,” Technical Report USCG RDC, UDI 1732, October 2017.
- [12] International Maritime Organization, “Amendments to the Revised NAVTEX Manual,” IMO, London, UK, MSC.1/Circ. 1403/Rev.1, 25 November 2016.
- [13] International Telecommunications Union, “System for digital sound broadcasting in the broadcasting bands below 30 MHz,” International Telecommunications Union Radiocommunication Sector, Recommendation ITU-R Rec. BS.1514-2, March 2011.



## HF Digital Radio Mondiale (DRM) Broadcast Summary Report

---

- [14] International Telecommunications Union “Characteristics of a Digital System, Named Navigational Data for Broadcasting Maritime Safety and Security Related Information from Shore-to-Ship in the Maritime HF frequency band,” International Telecommunications Union Radiocommunication Sector ITU-R. M.2058-0, February 2014.
- [15] European Broadcasting Union, “Technical Bases for DRM Services Coverage Planning,” EBU-UER, Geneva, Report EBU Tech 3330, June 2008.
- [16] G. W. Johnson and I. M. Gonin, “Long Range Transmissions of AIS Maritime Safety Information,” Contract deliverable report number 4 for task order 6, 22 July 2016.
- [17] J. Briggs, “Digital Broadcasting Below 30 MHz: DRM – a Summary of Field Tests,” EBU Technical Review, October 2003.
- [18] European Telecommunications Standards Institute, “Digital Radio Mondiale (DRM); Multiplex Distribution Interface (MDI),” European Telecommunications Standards Institute (ETSI) ETSI TS 102 820 V4.1.1, March 2016.





## APPENDIX A. CODE OF FEDERAL REGULATIONS ON DRM

### Title 47 - Telecommunication

Volume: 4

Date: 2017-10-01

Original Date: 2017-10-01

Title: Section 73.758 - System specifications for digitally modulated emissions in the HF broadcasting service.

Context: Title 47 - Telecommunication. CHAPTER I - FEDERAL COMMUNICATIONS COMMISSION (CONTINUED).

SUBCHAPTER C - BROADCAST RADIO SERVICES. PART 73 - RADIO BROADCAST SERVICES. Subpart F - International Broadcast Stations.

#### § 73.758 System specifications for digitally modulated emissions in the HF broadcasting service.

(a) **For digitally modulated emissions, the Digital Radio Mondiale (DRM) standard shall be employed.** Both digital audio broadcasting and datacasting are authorized. The RF requirements for the DRM system are specified in paragraphs (b) and (c), of this section.

(b) System parameters— (1) Channel spacing. The initial spacing for digitally modulated emissions shall be 10 kHz. However, interleaved channels with a separation of 5 kHz may be used in accordance with the appropriate protection criteria appearing in Resolution 543 (WRC-03), provided that the interleaved emission is not to the same geographical area as either of the emissions between which it is interleaved.

(2) Channel utilization. Channels using digitally modulated emissions may share the same spectrum or be interleaved with analog emissions in the same high frequency broadcasting (HFBC) band, provided the protection afforded to the analog emissions is at least as great as that which is currently in force for analog-to-analog protection. Accomplishing this may require that the digital spectral power density (and total power) be lower by several dB than is currently used for either DSB or SSB emissions.

(c) Emission characteristics— (1) Bandwidth and center frequency. A full digitally modulated emission will have a 10 kHz bandwidth with its center frequency at any of the 5 kHz center frequency locations in the channel raster currently in use within the HFBC bands. Among several possible “simulcast” modes are those having a combination of analog and digital emissions of the same program in the same channel that may use a digital emission of 5 kHz or 10 kHz bandwidth, next to either a 5 kHz or 10 kHz analog emission. In all cases of this type, the 5 kHz interleaved raster used in HFBC shall be adhered to in placing the emission within these bands.

(2) Frequency tolerance. The frequency tolerance shall be 10 Hz. See Section 73.757(b)(2), notes 1 and 2.

(3) Audio-frequency band. The quality of service, using digital source coding within a 10 kHz bandwidth, taking into account the need to adapt the emission coding for various levels of error avoidance, detection and correction, can range from the equivalent of monophonic frequency modulation (FM; approximately 15 kHz) to the low-level performance of a speech codec (of the order of 3 kHz). The choice of audio quality is connected to the needs of the broadcaster and listener; and includes the consideration of such characteristics as the propagation conditions expected. There is no single specification, only the upper and lower bounds noted in this paragraph.



## HF Digital Radio Mondiale (DRM) Broadcast Summary Report

---

(4) Modulation. Quadrature amplitude modulation (QAM) with orthogonal frequency division multiplexing (OFDM) shall be used. 64-QAM is feasible under many propagation conditions; others such as 32-, 16- and 8-QAM are specified for use when needed.

(5) RF protection ratio values. The protection ratio values for analogue and digital emissions for co-channel and adjacent channel conditions shall be in accordance with Resolution 543 (WRC-03) as provisional RF protection ratio values subject to revision or confirmation by a future competent conference.

[70 FR 46677, Aug. 10, 2005]



## APPENDIX B. DRM INSTALLATION

This Appendix contains a detailed description of the DRM configuration for RDC's field test.

### B.1 Transmitter System

A block diagram of the COMMSTA Kodiak installation, previously included as Figure 6, is repeated here for convenience as Figure B-1.

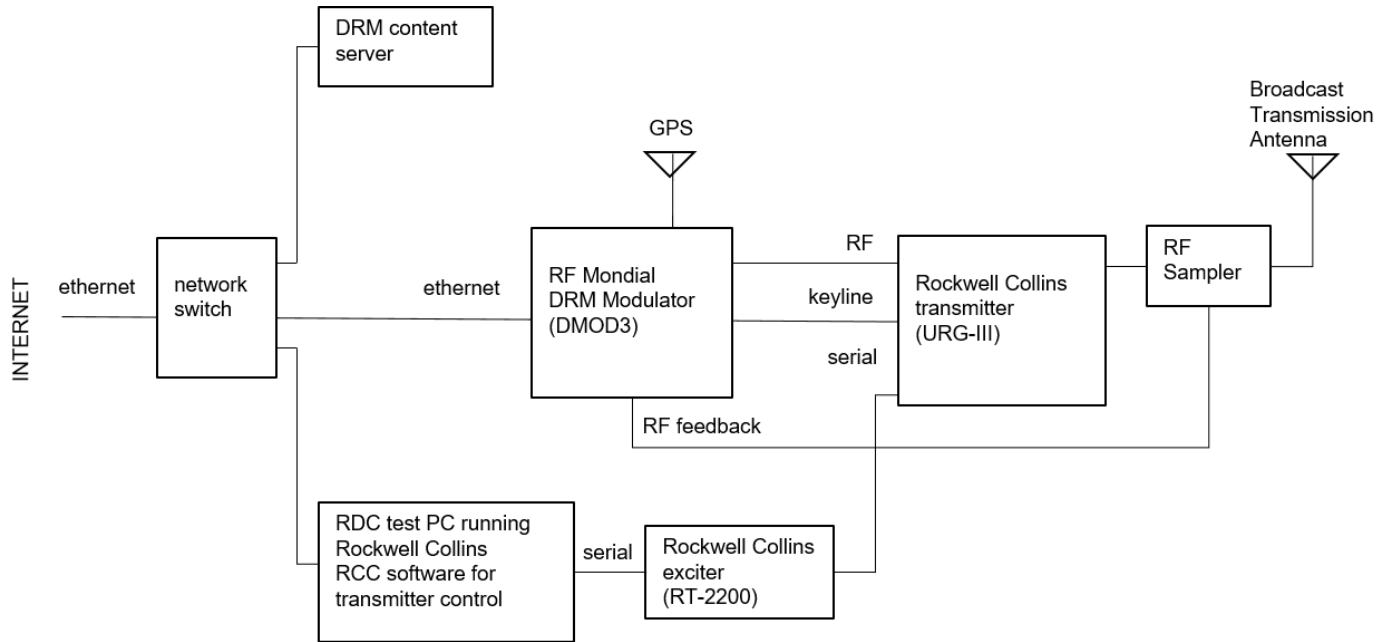

Figure B-1. Kodiak installation block diagram.

The DRM transmission equipment was located in COMMSTA Kodiak's transmitter and control rooms. The COMMSTA allocated HF transmitter #12 and the TCI-530 (later switched to the TCI-550 antenna) for the continuous transmission of the DRM signal. As seen in Figure B-2, the RDC installed the content server, DMOD3 modulator, and an Ethernet switch into a portable server rack placed next to the transmitter. The modulator connected directly to the transmitter using an RG-58 BNC cable to the transmitter input replacing the COMMSTA's connection from the Rockwell Collins RT-2200 exciter. This is connected to RF out 1 (x112) on the DMOD3.

## HF Digital Radio Mondiale (DRM) Broadcast Summary Report



Figure B-2. (Left) Kodiak HF transmitter #12 (tall cabinet on end) and portable server rack, (Right) close up of the portable server rack housing the content server, DMOD3 modulator, and Ethernet switch.

The modulator and content server were both connected to the rack-mounted Ethernet switch. COMMSTA Kodiak personnel ran CAT-5 Ethernet cable in the overhead from the Ethernet switch to their non-secure router with Internet access, and from the switch to the control computer (Figure B-3). This control station allows for both local and remote control of the transmitter, content server, DMOD3, and data processes running on the computer.

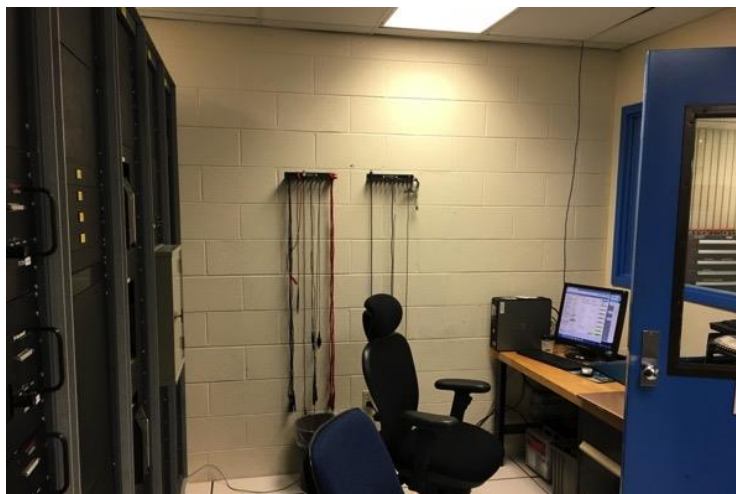

Figure B-3. Kodiak desktop control computer (on desk).

Transmitter control was provided by Rockwell Collins RCC software which communicated with the RT-2200 exciter (Figure B-3 (left)) using a DB-9, RS-232 serial connection which was installed between the computer and exciter. The exciter is located approximately 10 feet from the computer in the control room area in a large cabinet rack. A 25 ft. serial cable was run from the computer to the rear of the exciter (connector J10) through the cabinet's rear door. A jumper was placed on the 37-pin of the exciter to allow control of the exciter from the RS-232 serial connection (Figure B-3 (right)). Without the jumper, the exciter



## HF Digital Radio Mondiale (DRM) Broadcast Summary Report

may only be controlled by the RS-422 connection normally used by the COMMSTA. Remote access to the desktop computer was provided using a dedicated LogMeIn account.



Figure B-4. Front of Rockwell Collins RT-2200 Exciter (left), rear of RT-2200 showing jumper location (right).

In the initial correspondence with Rockwell Collins, the vendor was unsure if the transmitter would be capable of running with a 100% duty cycle. This uncertainty led to the initial plan to only transmit for a window of each hour. Therefore, a connection between the transmitter and modulator was established which would allow the modulator to secure the transmitter output using a relay on the DMOD3. This relay was tapped into the antenna interlock of the transmitter Figure B-5. The antenna interlock is used by the COMMSTA, which has the ability to remotely connect any of their HF antennas to any of the transmitters as the need arises. It was important to ensure the COMMSTA's safety interlock was still functional as they have the authority to use the TCI-530 antenna when needed. If one or both of the interlocks were activated, the transmitter would not allow for transmission. A relay on the DMOD3 modulator was programmed to secure the transmitter anytime the DRM input from the content server ceased. This allowed the content server's broadcast scheduling system to control the DRM transmissions.

RDC found during initial testing that the transmitter was capable of running continuously, but the interlock still allows for an added layer of safety and control so was left in place. If, for some reason, the RCC software was unresponsive, the transmitter could be secured by deactivating the DRM stream in the content server.



## HF Digital Radio Mondiale (DRM) Broadcast Summary Report



Figure B-5. Transmitter antenna interlock circled in red (left) and installed RF tap circled in orange (right).

A tap on the amplifier feed to the antenna was also installed in order to provide feedback to the modulator (see right side of Figure B-5). A coaxial dynamics 7999 Variable RF sampler was installed inline between the amplifier output and the antenna feed line. The RF sampler has a BNC tap port that was set to approximately -50dB. This was connected with RG-58 coaxial cable to the DMOD3, as seen in Figure B-6.



Figure B-6. Back of DMOD3 showing RF output and RF input connections.



## B.2 Receive Systems

This section presents site-specific installation information for the shore installation at Cordova as well as the installations on the USCGC SYCAMORE, HEALY and MAPLE. All the receiver systems used in the field test have the same general configuration as shown in Figure 8 which is repeated here as Figure B-7 for convenience.

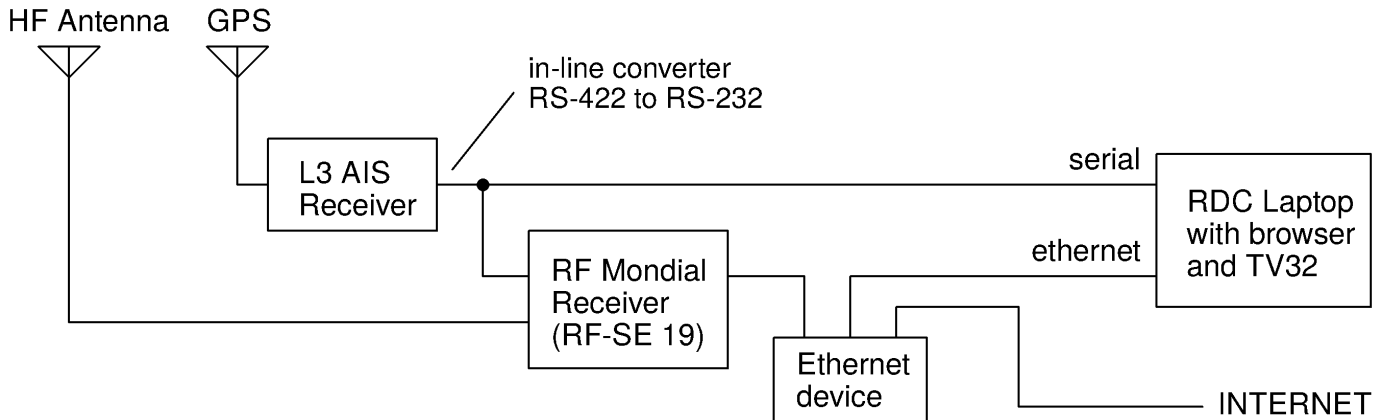

Figure B-7. Block diagram of receiver systems.

### B.2.1 Cordova Receiver

The shore-based monitor receiver was located inside the USCGC SYCAMORE's shore support building. The laptop computer, receiver, and cellular modem/router were placed on top of a cabinet in one of their storage rooms (see Figure B-8). The crew chose this location due to its low traffic and close proximity to the antenna.

The laptop computer and the receiver were connected using CAT-5 Ethernet cable to the Peplink Pepwave Verizon cellular modem/router (on the left of the computer in Figure B-8). The modem received a strong 4G LTE signal without the use of an external antenna in its installed location. The laptop computer allowed for local viewing of the receiver's web interface and hosted the LogMeIn connection used for offsite remote access. The receiver stored all logs to an internal hard drive in the receiver. These files were then downloaded over the LogMeIn connection using the receiver's web graphical user interface (GUI).

Electronics Technicians (ETs) from the USCGC SYCAMORE ran LMR-240 cable from the receiver to the antenna. The ship's crew also assisted with installing the loop antenna on top of a flammable storage locker using a tripod mount with adequate weight to hold it in place (see Figure B-8 (right)). The antenna was then pointed towards the transmission source in Kodiak, Alaska.



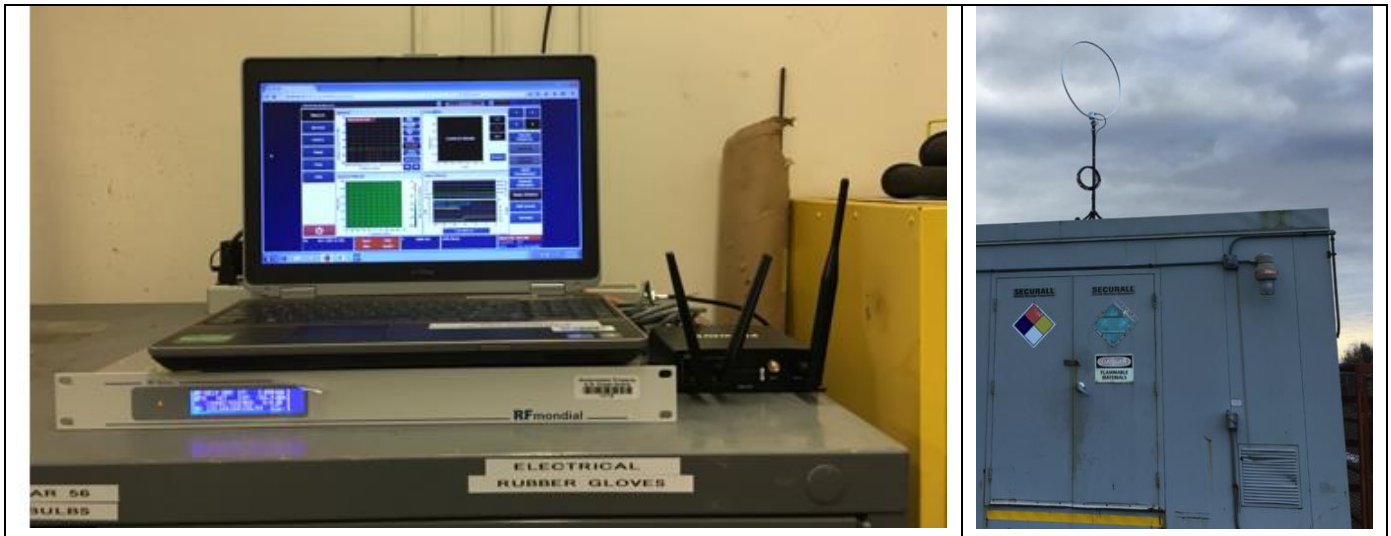

Figure B-8. (Left) Monitor receiver, laptop, and Verizon cellular modem on top of cabinet, (Right) Monitor receiver's directional loop antenna.

## B.2.2 USCGC SYCAMORE Receiver

The ship installation was nearly identical to the shore installation, besides a few additional connections. The laptop computer used to connect and display information from the receiver was placed in the corner of the bridge's chart table (see Figure B-9). This area was chosen because it is outside the usable area of the table due to the placement of the ship's navigation laptop. The receiver and laptop were connected through a Wi-Fi-enabled Linksys router using CAT-5 Ethernet cables. The Wi-Fi portion of the router was active to allow the ship's personnel to access the receiver using any Wi-Fi enabled device with a web browser. This connection only allowed access to the receiver's web-hosted multimedia player and was not connected to the Internet. The laptop computer could be accessed remotely when the ship was in port using the laptop's internal Wi-Fi card, which linked to the router in the shore support building when in Wi-Fi range.



Figure B-9. Laptop located on chart table onboard SYCAMORE.

The DRM receiver was installed in a rack cabinet (Figure B-10) directly forward of the chart table in the same space. This receiver had two additional connections that differ from the shore unit. A USB hub was



## HF Digital Radio Mondiale (DRM) Broadcast Summary Report

connected to the receiver's USB port, which allowed access to download GPS data and the storage of log files to a removable flash drive. GPS data was acquired using the ship's L3 Protec-M AIS receiver's pilot port, which is located near the helm on the bridge. The pilot port provides the data to the receiver using a DB-9 serial cable run through the overhead existing cableways to the rear of the cabinet housing the receiver. A serial-to-USB converter was used to interface with the USB hub. The flash drive was initially included to allow the crew to periodically replace the drive and mail logged data back to the RDC for analysis. After installing the ship and shore receivers it was found that the Wi-Fi signal from the cellular router was sufficiently strong to reach the ship allowing direct download of log files through LogMeIn. The flash drive remained as a backup to the data stored on the receiver's internal hard drive.



Figure B-10. USCGC SYCAMORE receiver mounted in cabinet rack in bridge chart room.

The omnidirectional side feed HF whip antenna was mounted directly above the charting area of the bridge to the inside of a stanchion (Figure B-11 (left)). It was secured using two adjustable rail mounts that were lined with rubber matting to avoid damage to the ship and antenna. USCGC SYCAMORE personnel routed the LMR-240 cable from the charting area to the antenna through an existing stuffing tube (Figure B-11



## HF Digital Radio Mondiale (DRM) Broadcast Summary Report

---

(right)). This cable was then terminated using a BNC connector for the receiver and a ring terminal to the side feed post of the antenna. The antenna and cable shield were grounded to an existing grounding point on the flag locker located just to the Port side of the antenna (Figure B-12).



Figure B-11. Antenna (circled in red) mounted to inside of rail on deck above bridge on USCGC SYCAMORE. Close-up of rail mount on right.





Figure B-12. Antenna cable run through existing stuffing tube.



# HF Digital Radio Mondiale (DRM) Broadcast Summary Report

## USCGC HEALY Receiver

In April 2017, the RDC moved the equipment from USCGC SYCAMORE to USCGC HEALY; the equipment was installed in a similar fashion. A block diagram of the installation is shown in Figure B-7. The receiver was located in a rack in the radio room (Figure B-13 (left)) and the laptop was installed on the bridge (not shown). HEALY's L3 AIS receiver was used to provide GPS data via the Pilot Port connection, as was done on the SYCAMORE. One of the ship's existing HF antennas was used (Figure B-13 (right)); a Shakespeare 222-b 35ft whip located on the port side flying bridge. The antenna was directly connected to the receiver with no coupler or tuning unit.



Figure B-13. DRM receiver installed in USCGC HEALY's radio room. The antenna on the port side flying bridge was used.



## HF Digital Radio Mondiale (DRM) Broadcast Summary Report

### B.2.3 USCGC MAPLE Receiver

In July 2017, the RDC relocated the equipment from Cordova, AK to USCGC MAPLE and installed it in a similar fashion to the SYCAMORE. The receiver was located in the rack in the chart room the same as the SYCAMORE, and the laptop was installed in the same rack (see Figure B-14 (left)). The AIS receiver on the bridge was used to provide GPS data via the Pilot Port connection, as was done on the SYCAMORE. One of the ship's existing HF antennas, a Shakespeare model 390, was used (see Figure B-14 (right)).



Figure B-14. (Left) Receiver and laptop mounted in rack in chart room on USCGC MAPLE. (Right) The HF receive antenna, located on starboard aft corner of bridge wing.



## APPENDIX C. FIELD TEST DATA SOURCES AND DISPLAY

This Appendix presents an overview of the data incorporated into RDC's field test of the DRM system. The transmitter system retrieves, general marine and navigation safety information, news, and sports from the Internet, and loads it onto RFmondial/Fraunhofer DRM content server. In parallel, the system retrieves Application Specific Messages (ASMs) from the internet and formats them as AIS messages, packages them as a File Transfer Protocol (FTP) file, and sends them to the Content Server via a network connection. Next, using the standard DRM Journaline service, the Content Server formats all the information and schedules them for broadcast according to the bandwidth allocated for each data type. The information flows to the Transradio DRM modulator using a standard Multiplex Distribution Interface (MDI) data stream where it is encoded and modulated to a RF signal. An existing USCG HF amplifier bolsters the RF signal before eventually broadcasting through one of the USCG's HF antennas.

### C.1 Data Sources

The RDC established various data sources on the source computer to provide information to the transmit system for the AIS and Journaline channels.

#### C.1.1 AIS Data Sources

National Data Buoy Center (NDBC) provides the weather information collected from its weather buoys. As seen in Figure C-1, in this field test, the RDC uses the feeds from six buoys, located at Arctic Alaska, to inform the ship's crew of the weather measurements in the area: Albatross Bank buoy<sup>2</sup>, Cape Cleare buoy<sup>3</sup>, Cape Suckling buoy<sup>4</sup>, Portlock Bank buoy<sup>5</sup>, Seal Rocks buoy<sup>6</sup>, and West Orca Bay<sup>7</sup>.

---

<sup>2</sup> RSS feed: [http://www.ndbc.noaa.gov/data/latest\\_obs/46078.rss](http://www.ndbc.noaa.gov/data/latest_obs/46078.rss)

<sup>3</sup> RSS feed: [http://www.ndbc.noaa.gov/data/latest\\_obs/46076.rss](http://www.ndbc.noaa.gov/data/latest_obs/46076.rss)

<sup>4</sup> RSS feed: [http://www.ndbc.noaa.gov/data/latest\\_obs/46082.rss](http://www.ndbc.noaa.gov/data/latest_obs/46082.rss)

<sup>5</sup> RSS feed: [http://www.ndbc.noaa.gov/data/latest\\_obs/46080.rss](http://www.ndbc.noaa.gov/data/latest_obs/46080.rss)

<sup>6</sup> [http://www.ndbc.noaa.gov/data/latest\\_obs/46061.rss](http://www.ndbc.noaa.gov/data/latest_obs/46061.rss)

<sup>7</sup> [http://www.ndbc.noaa.gov/data/latest\\_obs/46060.rss](http://www.ndbc.noaa.gov/data/latest_obs/46060.rss)



# HF Digital Radio Mondiale (DRM) Broadcast Summary Report

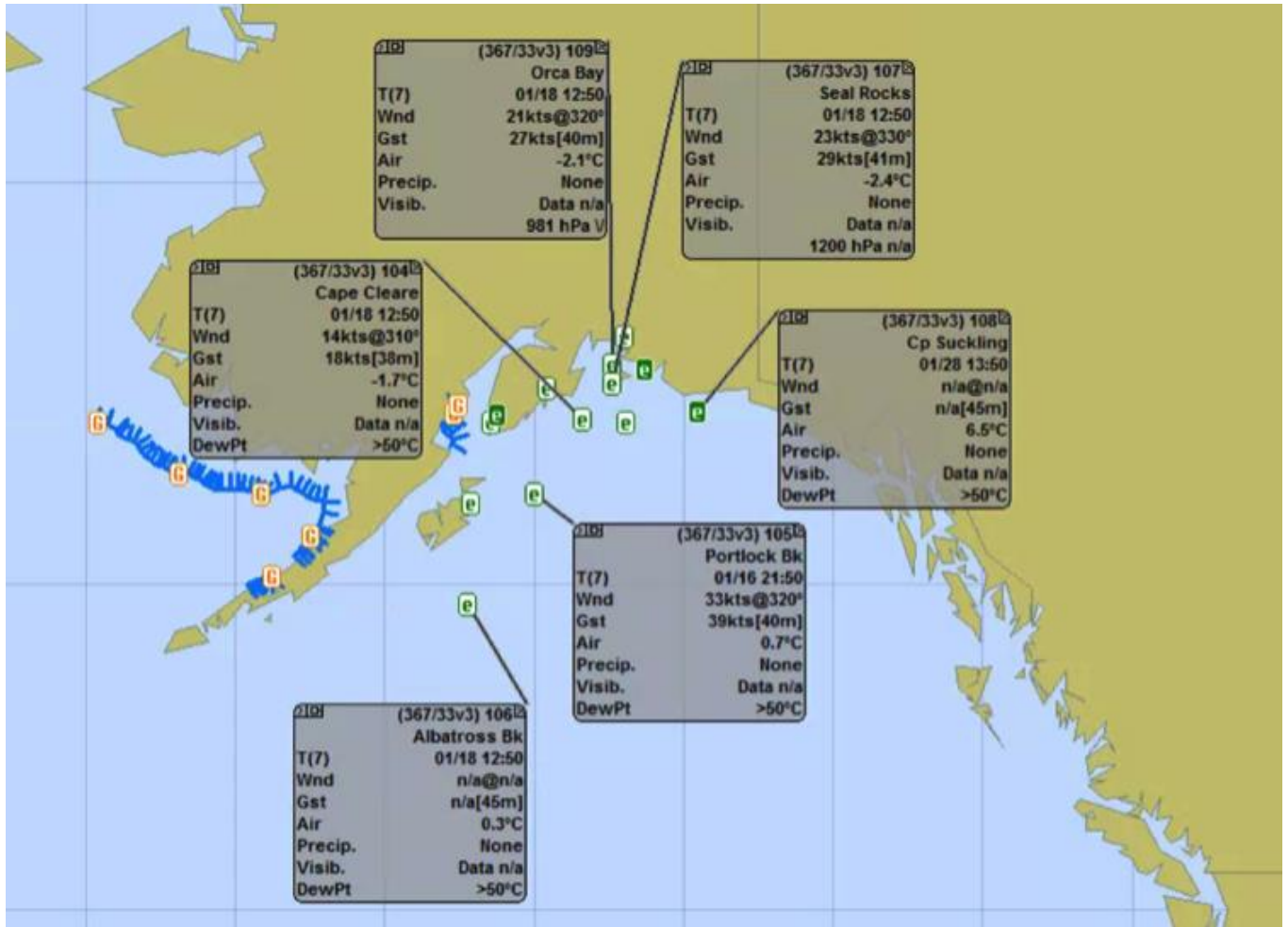

Figure C-1. TV32 display of AIS weather buoys.



## HF Digital Radio Mondiale (DRM) Broadcast Summary Report

Additionally, the RDC included NOAA's National Weather Service (NWS) feeds from several Weather Stations to provide regional weather information such as storms, winds, flooding, and tornados, to mariners. The selected Arctic weather stations include Cordova Airport<sup>8</sup>, Homer Spit View<sup>9</sup>, Kodiak Airport<sup>10</sup>, Middleton Island<sup>11</sup>, Seldovia<sup>12</sup>, Seward Airport<sup>13</sup>, and West Lowe St.<sup>14</sup> Figure C-2 shows the data from these stations as viewed on the RDC's TV32.

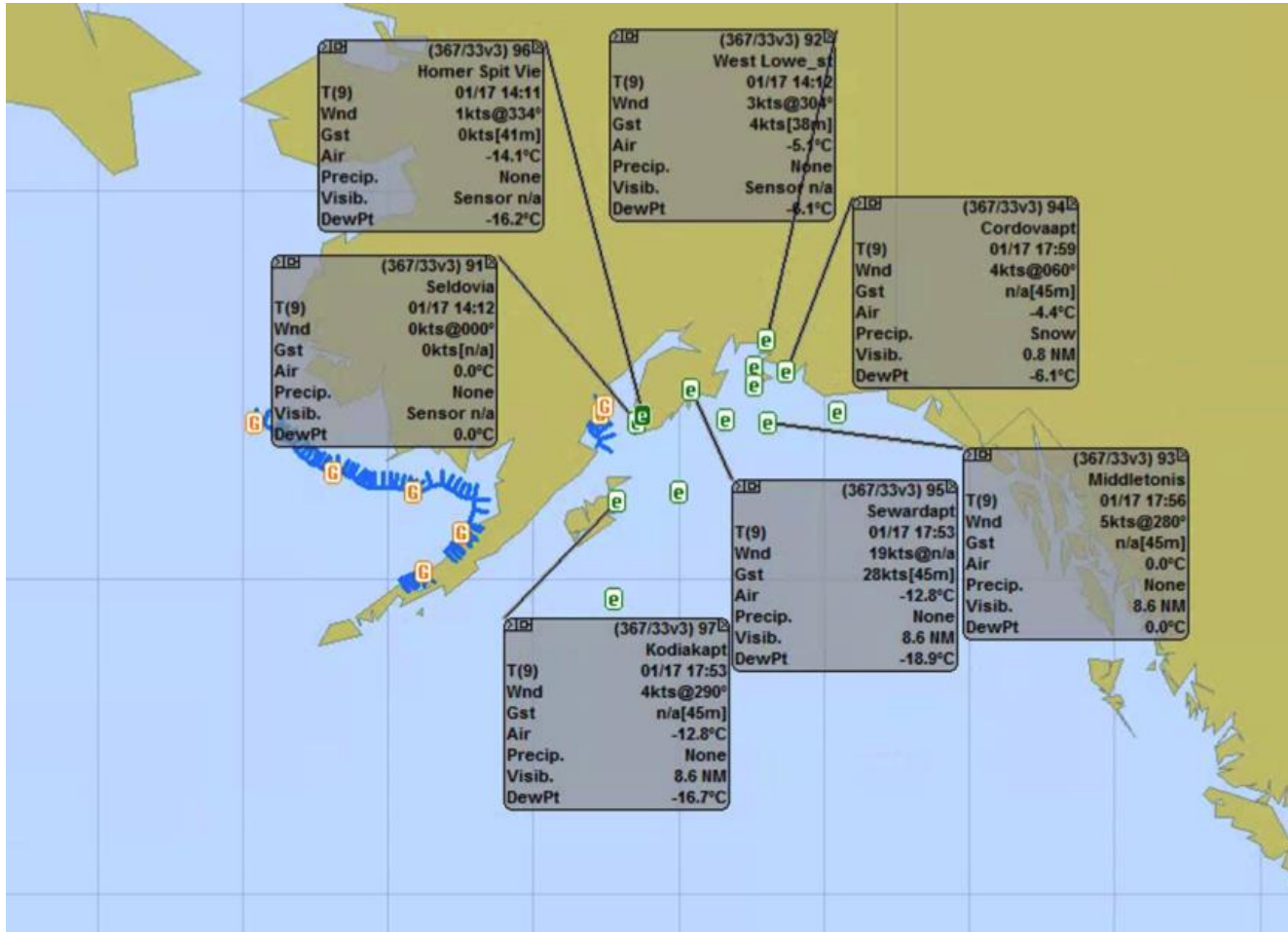

Figure C-2. TV32 display of AIS weather stations.

<sup>8</sup> See <ftp://tgftp.nws.noaa.gov/data/observations/metar/stations/PACV.TXT>.

<sup>9</sup> See <http://www.weatherlink.com/user/akjerry/index.php?view=summary&headers=0&type=1>

<sup>10</sup> See <ftp://tgftp.nws.noaa.gov/data/observations/metar/stations/PADQ.TXT>

<sup>11</sup> See <ftp://tgftp.nws.noaa.gov/data/observations/metar/stations/PAMD.TXT>

<sup>12</sup> See <http://www.weatherlink.com/user/sbferry/index.php?view=summary&headers=0&type=1>

<sup>13</sup> See <ftp://tgftp.nws.noaa.gov/data/observations/metar/stations/PAWD.TXT>

<sup>14</sup> See <http://www.weatherlink.com/user/westlowe2/index.php?view=summary&headers=0&type=1>





# HF Digital Radio Mondiale (DRM) Broadcast Summary Report

Moreover, the RDC fetched the NOAA’s National Ice Center forecast of Ice Edges<sup>15</sup>. Figure C-3 shows one example of this information as seen on TV32 software.

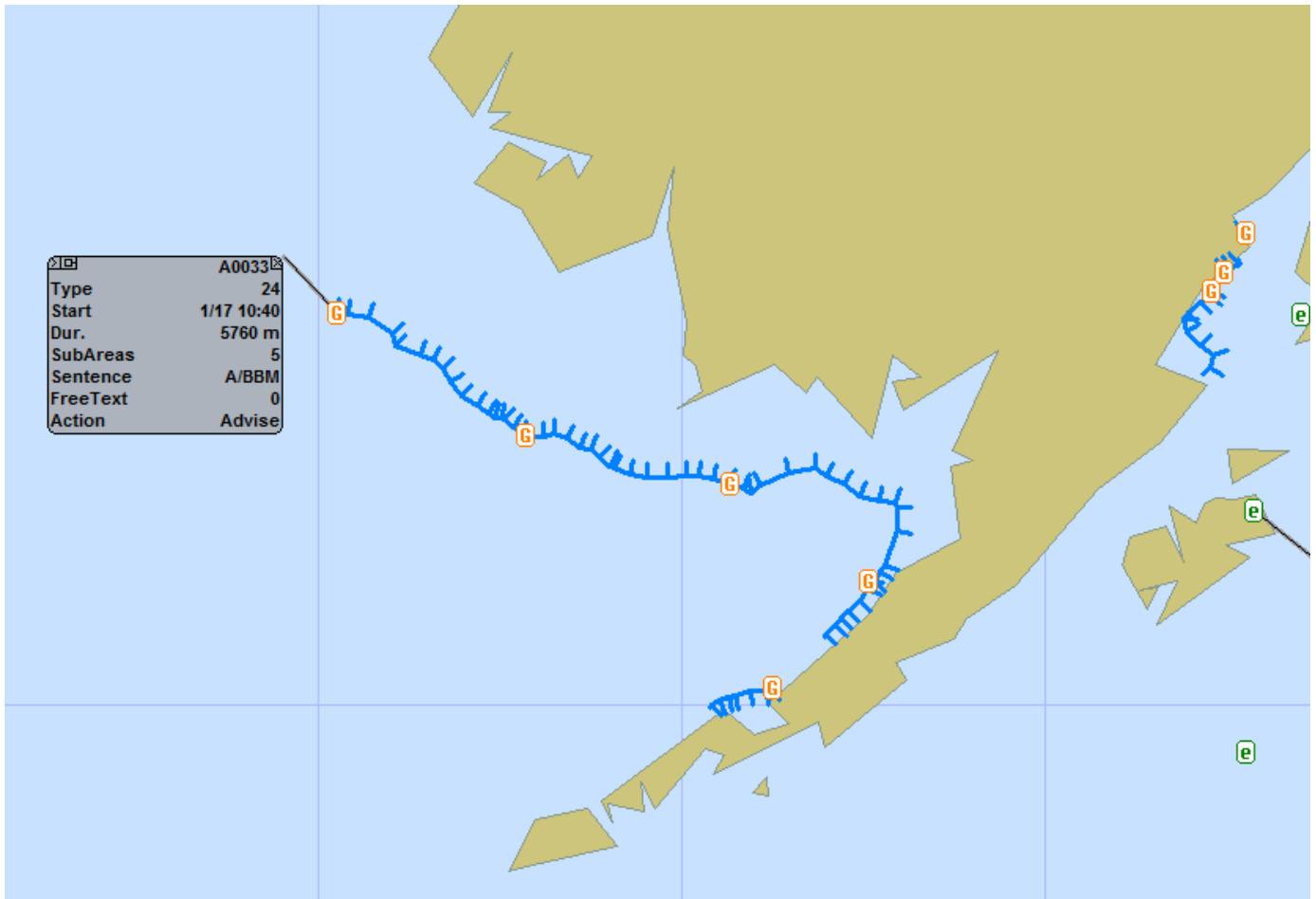

Figure C-3. TV32 display of AIS ice edges.

## C.1.2 Journaline Data Sources

Figure C-4 shows the outline of the Journaline service in the RDC’s field test. This section provides details about each of these services.

<sup>15</sup> See the feed at [http://www.natice.noaa.gov/pub/daily/arctic/2015//text\\_overlay/novrly15.009](http://www.natice.noaa.gov/pub/daily/arctic/2015//text_overlay/novrly15.009)



# HF Digital Radio Mondiale (DRM) Broadcast Summary Report

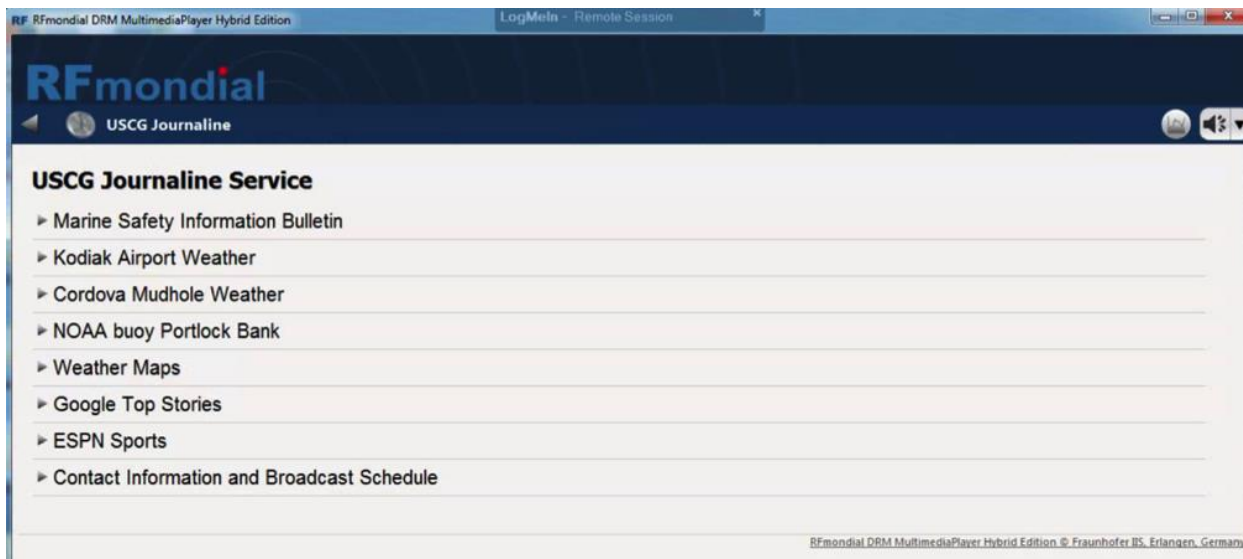

Figure C-4. Journaline service index.

USCG publishes Marine Safety Information Bulletin (MSIB) to inform and instruct the mariners on the safety issues that they may face. Therefore, as seen in Figure C-5, the RDC included MSIB into its Journaline service<sup>16</sup>.

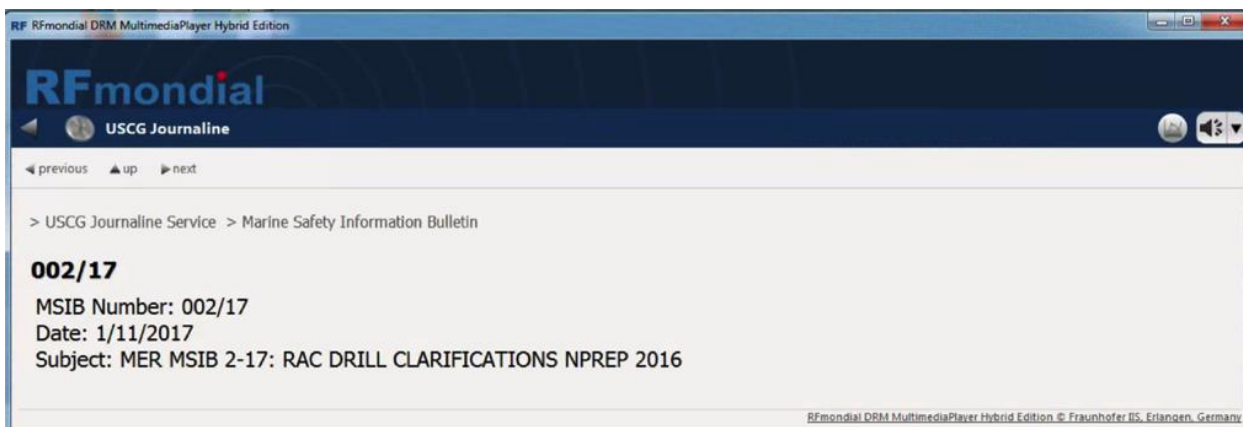

Figure C-5. Example of Journaline MSIB.

In addition to AIS, Journaline also presents the weather information from Weather Stations. As seen in C-6, contrary to the TV32-based Weather maps, Journaline provides a textual presentation of weather in Arctic to the users. The information is fetched from the RSS for Kodiak Airport<sup>17</sup> and Cordova Mudhole<sup>18</sup> weather stations.

<sup>16</sup> For RSS feed of MSIB, see <https://www.uscg.mil/msib/rss.ashx>

<sup>17</sup> See Kodiak Airport: [http://w1.weather.gov/xml/current\\_obs/PADQ.rss](http://w1.weather.gov/xml/current_obs/PADQ.rss)

<sup>18</sup> See [http://w1.weather.gov/xml/current\\_obs/PACV.rss](http://w1.weather.gov/xml/current_obs/PACV.rss)



# HF Digital Radio Mondiale (DRM) Broadcast Summary Report



Figure C-6. Example of Journaline weather station.

The RDC's Journaline also includes 48-hour Wind and Wave Forecast<sup>19</sup> in a visual format (Figure C-7). For the benefit of the mariner's, the RDC included Google Top Stories<sup>20</sup> as well.

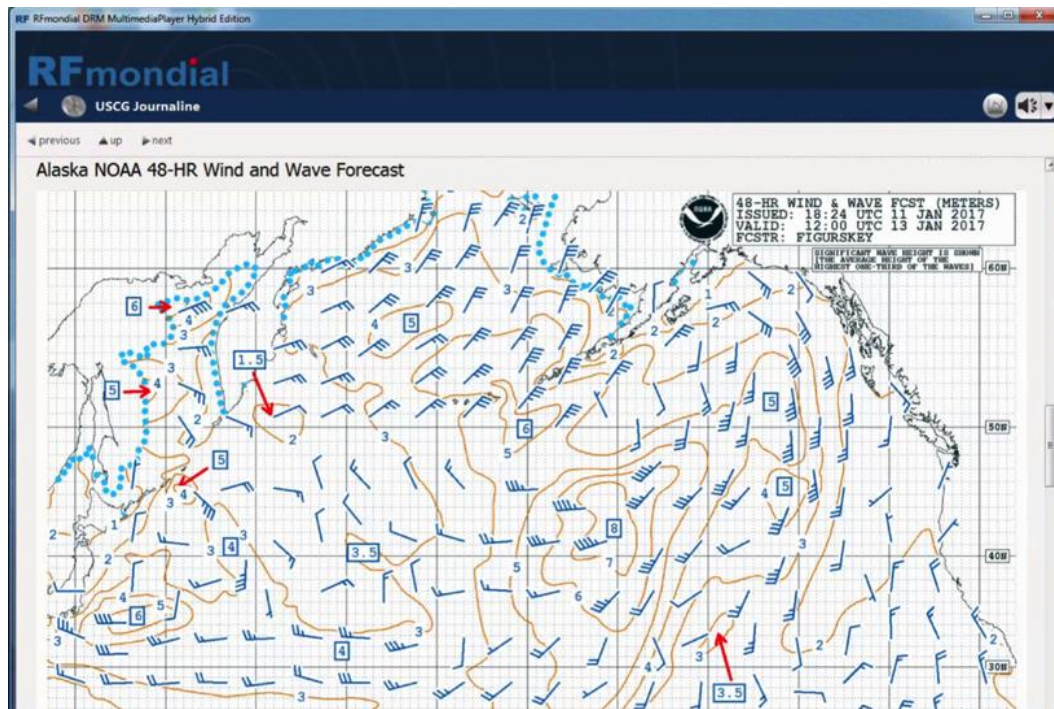

Figure C-7. Example of Journaline "48-hour Wind and Wave Forecast".

<sup>19</sup> See the latest forecast at <http://www.opc.ncep.noaa.gov/shtml/pjbi99.gif>

<sup>20</sup> The RSS for Google News' Top Story is at <https://news.google.com/news?cf=all&hl=en&pz=1&ned=us&output=rss>



# HF Digital Radio Mondiale (DRM) Broadcast Summary Report

In July 2017, the RDC updated the Journaline information feeds in order to support USCGC HEALY and USCGC MAPLE operations in Northern Alaskan waters. The result of these updates is shown in Figure C-8.

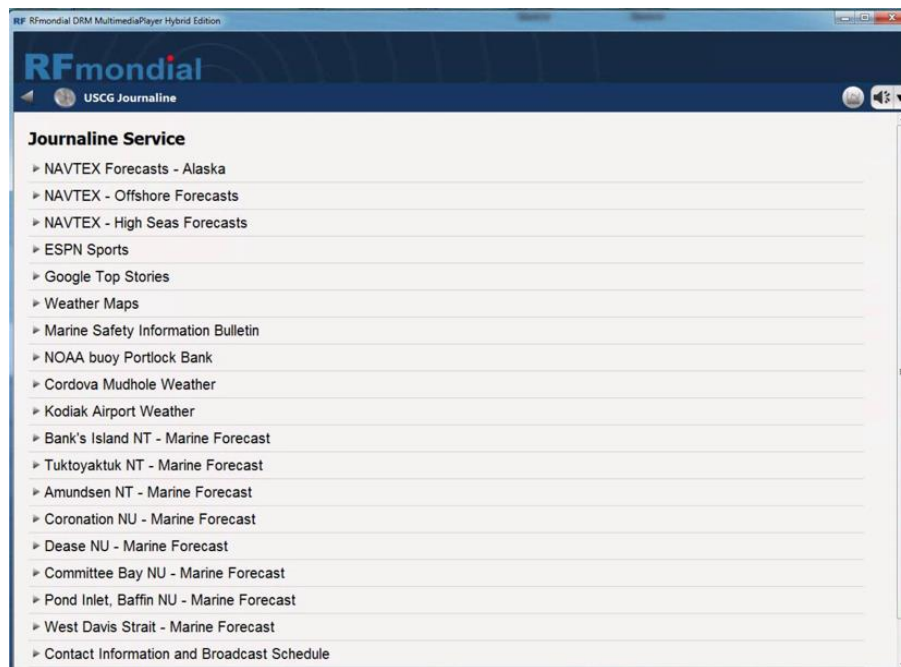

Figure C-8. Outline (index) of Journaline Service at end of field testing.

The NAVTEX data, a crucial part of the Journaline, is presented in a hierarchical manner. Clicking on *NAVTEX Forecasts – Alaska* leads to the *Alaska Coastal Waters Forecasts* page (see Figure C-9).

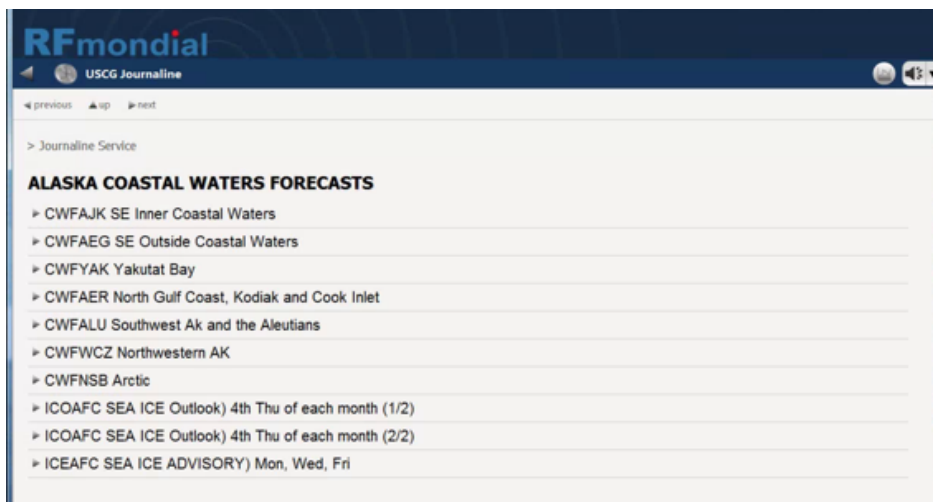

Figure C-9. Alaska Coastal Waters Forecasts NAVTEX options.

Clicking on one of the links brings up the next nested level. For example, clicking on *CWFAJK SE Inner Coastal Waters* brings up Figure C-10. Clicking on one of these links, for example *Glacier Bay*, brings up the relevant data (see Figure C-11).



# HF Digital Radio Mondiale (DRM) Broadcast Summary Report

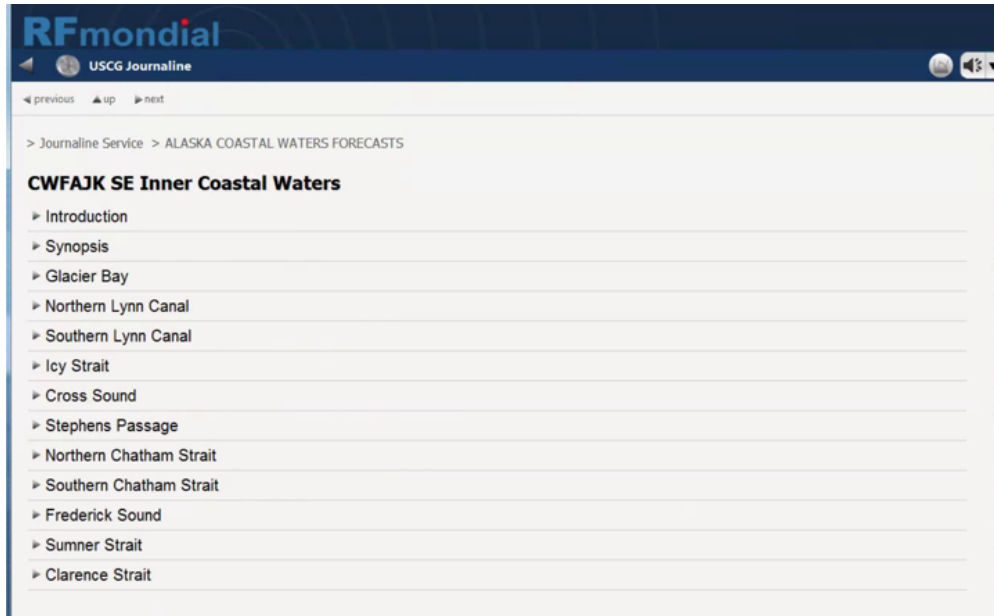

Figure C-10. One of the Alaska Coastal Waters Forecasts Selections.

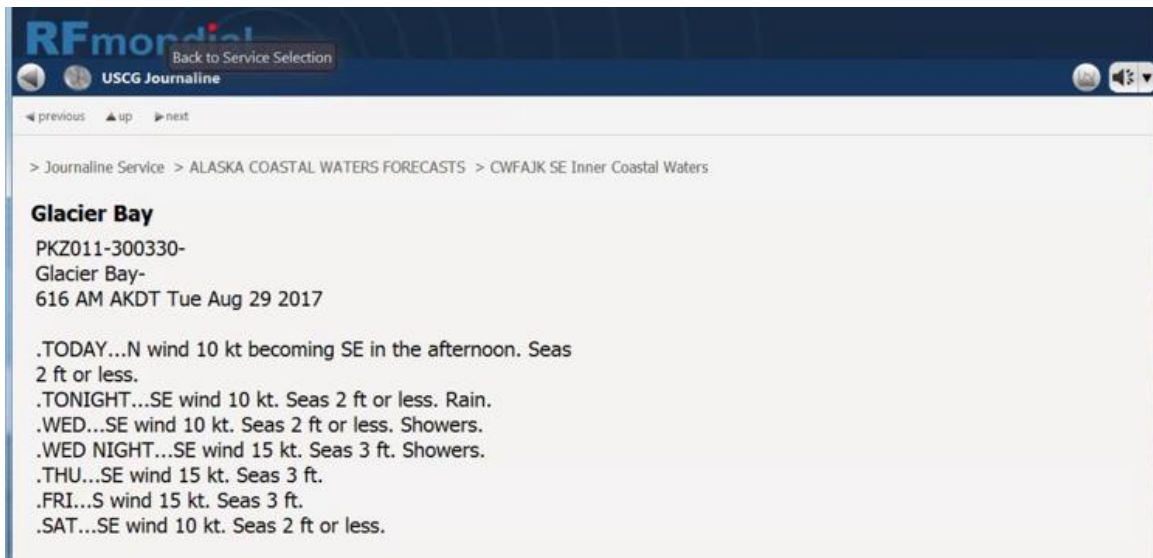

Figure C-11. Example of NAVTEX data.

The Marine forecasts are also hierarchical. Clicking on *Pond Inlet, Baffin NU – Marine Forecast* on the main Journaline page (Figure C-12), brings up the Pond Inlet selections (Figure C-13). Clicking on one of the options, *Forecast for Today* for example, presents the relevant data.



# HF Digital Radio Mondiale (DRM) Broadcast Summary Report

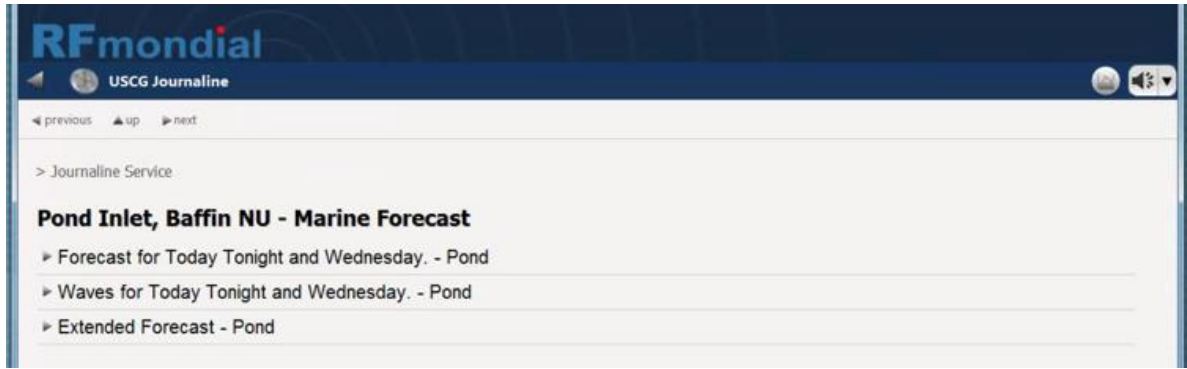

Figure C-12. Example of Journaline Marine Weather Forecast options.

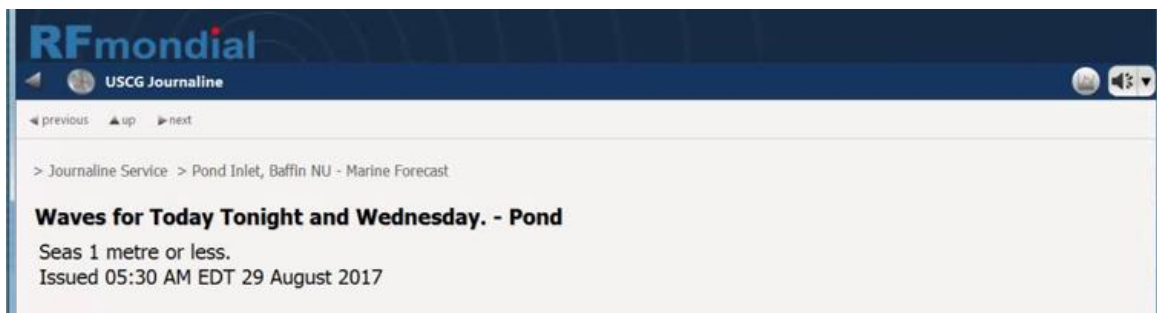

Figure C-13. Example of Journaline Marine Weather Forecast data.

The Weather Maps link brought up the page with a variety of maps. The final set consisted of the Current Weather Map, 24 and 48-hour wind and wave forecasts, and the daily sea ice concentrations as before. To this was added the 5-day Ice Forecast (Figure C-14) and the Canadian Ice Map (Figure C-15).



# HF Digital Radio Mondiale (DRM) Broadcast Summary Report

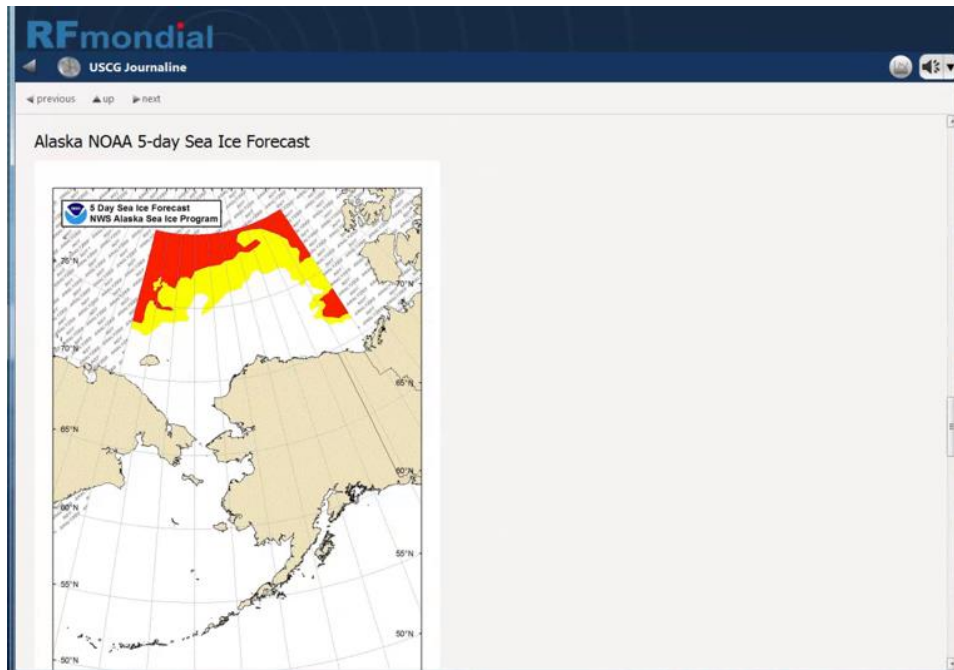

Figure C-14. Example of Journaline Weather Map “5-Day Sea Ice Forecast”.

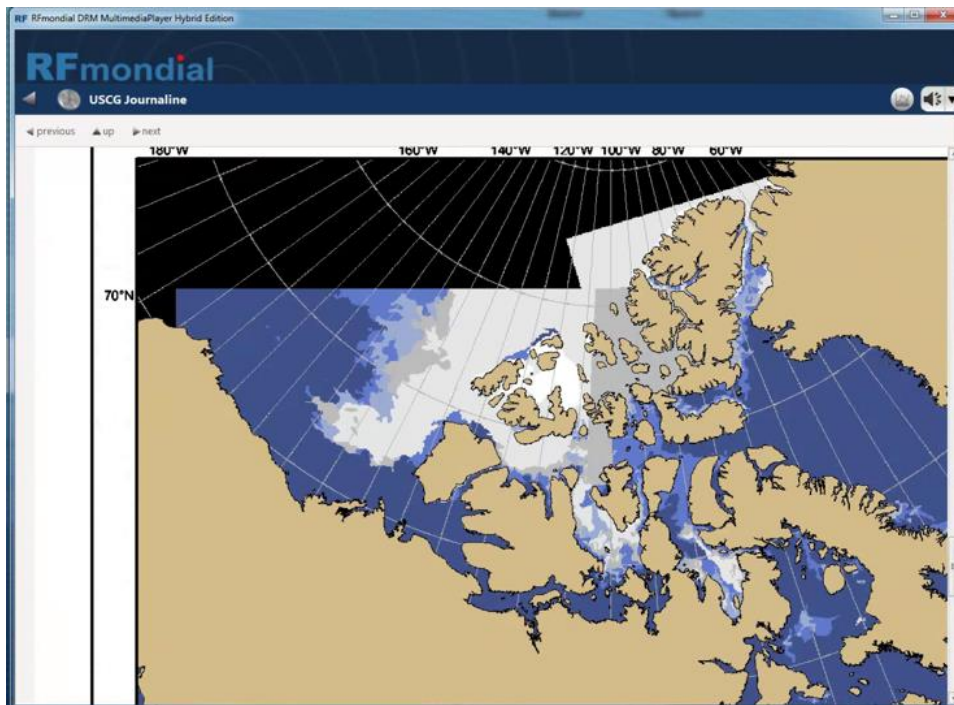

Figure C-15. Example of Journaline Weather Map, “Canadian Ice Map”.



## APPENDIX D. HF PROPIGATION MODEL

Data analysis for an HF system is not a simple endeavor as the HF sky-wave signals exhibit seasonal as well as daily variations. The propagation also changes based on the individual frequencies contained within the HF band; at certain time of day some frequencies are usable while others are completely ineffective. This is further complicated by the vast distances to be covered in the Arctic regions.

### D.1 Introduction to HF Propagation Model

The model-based forecasts contained in this document are built using the latest work from the International Telecommunication Union (ITU) as implemented in ATDI's Spectrum-E tool. To construct a sky wave based HF propagation forecast, the following items must be addressed:

- **Broadcast Frequency(s):** The ionosphere refraction is frequency dependent and constantly changing based on time of day, seasons, and solar activity. Different frequencies will skip via Skywave propagation to different locations (groundwave propagation at HF is not an effective method over the great distances involved in the Arctic). Frequency diversity is a key strategy to mitigate the skip zones. Simultaneous broadcasts or rotating frequency on a predetermined schedule provides the highest likelihood of reaching all users.
- **Antenna Type:** The model is very sensitive to the types of transmitting antenna APPENDIX E presents the performance of the transmitting antennas considered in this report.
- **Transmitter Power:** Increasing the transmitter's power will improve the likelihood of establishing a link provided the antenna configuration and atmospheric conditions are conducive to establishing the link. Unfortunately, there will be times when no communications link is possible no matter what transmitter power is used.
- **Receive Noise Floor:** The noise floor describes the site dependent noise as measured at the receiver. Remote shore side locations enjoy an advantage when compared to ships and aircraft. The additional physical space and remote locations allow antenna placement far away from sources of electrical noise. Ships, and especially aircraft, are small platforms so the antenna will be physically close to undesirable sources of noise such as electrical power systems including alternators plus various electrical loads, and other communication and computer equipment.
- **Modulation Method:** The modulation method determines the minimum required Signal to Noise Ratio (SNR). To reliably demodulate a signal, a receiver must be able to "hear" it above the noise. Empirical data presented in Section 7 demonstrate that the SNR for the DRM system is approximately 15 dB.
- **Time:** Since HF propagation is dependent on the ionosphere which displays seasonal changes, it is necessary to specify the time of year. This seasonal effect is pronounced in the Arctic when the summer sun shines all day and in the winter when the sun is nearly absent. Note the commercial Spectrum-E tool provided by ATDI used to develop these forecasts has a one month granularity.
- **Sun Spot Number:** Skywave HF propagation depends on the ionosphere. The characteristics of the ionosphere are based on solar activity. There are local changes, diurnal changes and seasonal changes all modulated by the solar weather which varies on an 11-year cycle. Figure 1 presents the historical sun spot number for the past 400 years. As a rule, HF propagation is aided by increased solar activity. The actual sunspot numbers for each month as shown in Figure D-1 are used in the data analysis.





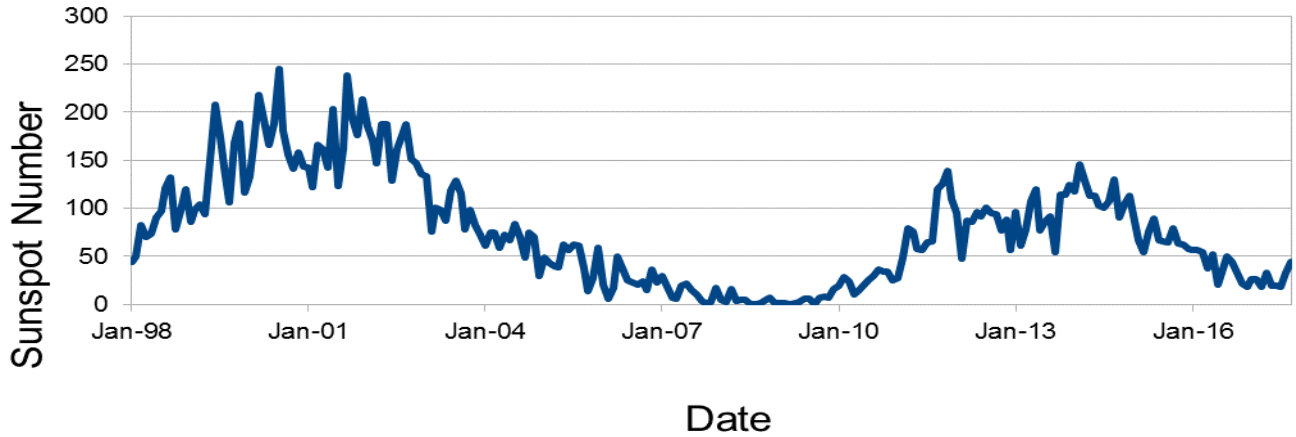

Figure D-1. Historical sunspot numbers.

## D.2 Propagation Patterns

To better understand some of the complexity of an HF broadcast, it is helpful to see how the signal changes over a typical day. Figure D-2 and Figure D-3 show a low and a mid-band frequency forecast progressing over a 24-hour period. For convenience, the transmitting station is placed at the intersection of the prime meridian and equator and the simulation is set for the spring equinox. This provides equal hours of day and night and most importantly, aligns local time with Coordinated Universal Time (UTC) to allow the user to quickly see the diurnal changes. For modeling purposes this fictional station has a broadcast power of 1000 W with an assumed 3 dB loss in the transmission and antenna path. Also, an omnidirectional antenna with a shallow take off angle is assumed.



# HF Digital Radio Mondiale (DRM) Broadcast Summary Report

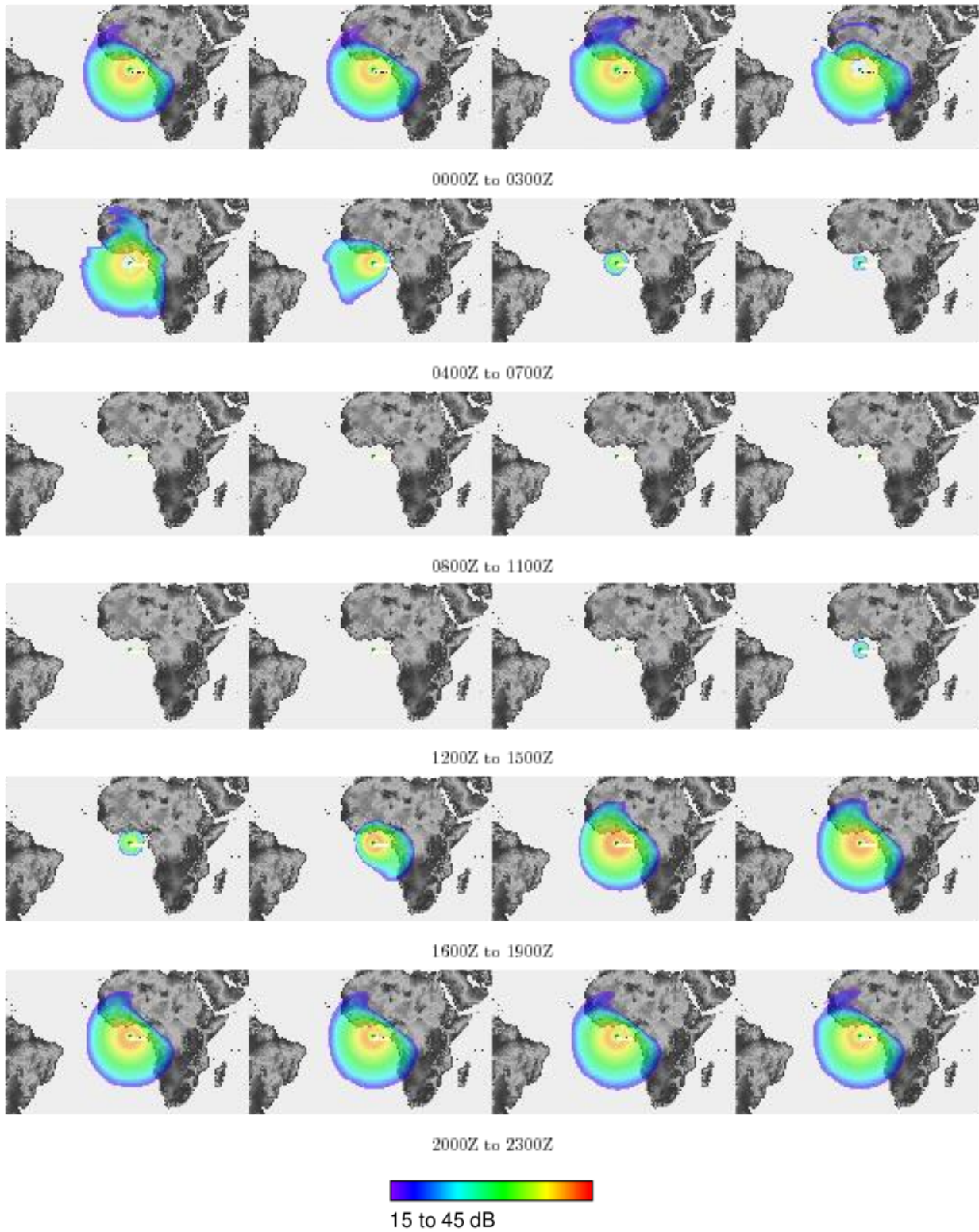

Figure D-2. 24-hour forecast of a 3.0 MHz signal. An SNR of at least 15 (violet) is required for voice communications.



# HF Digital Radio Mondiale (DRM) Broadcast Summary Report

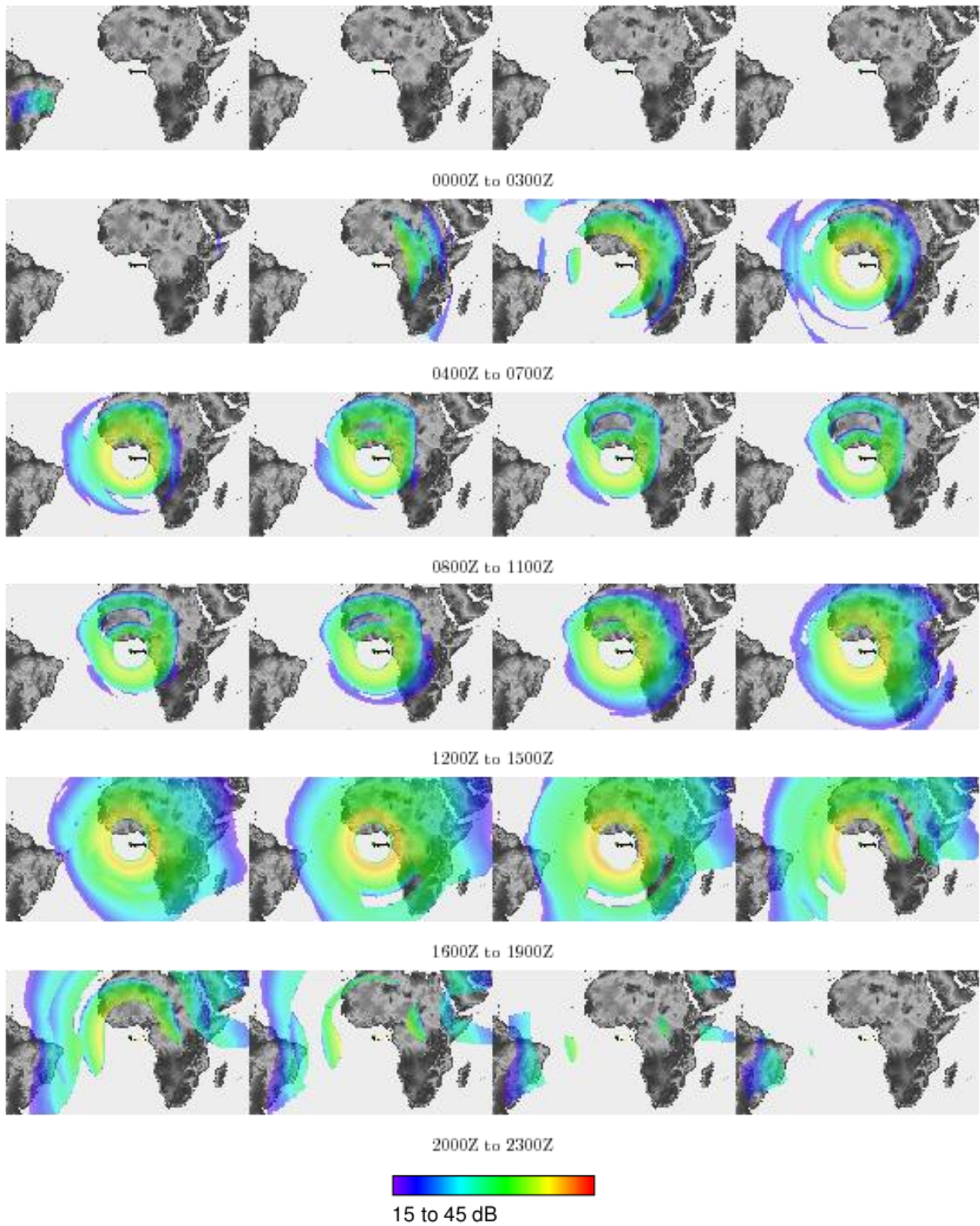

Figure D-3. 24 hour forecast of a 13.0 MHz signal.



# HF Digital Radio Mondiale (DRM) Broadcast Summary Report

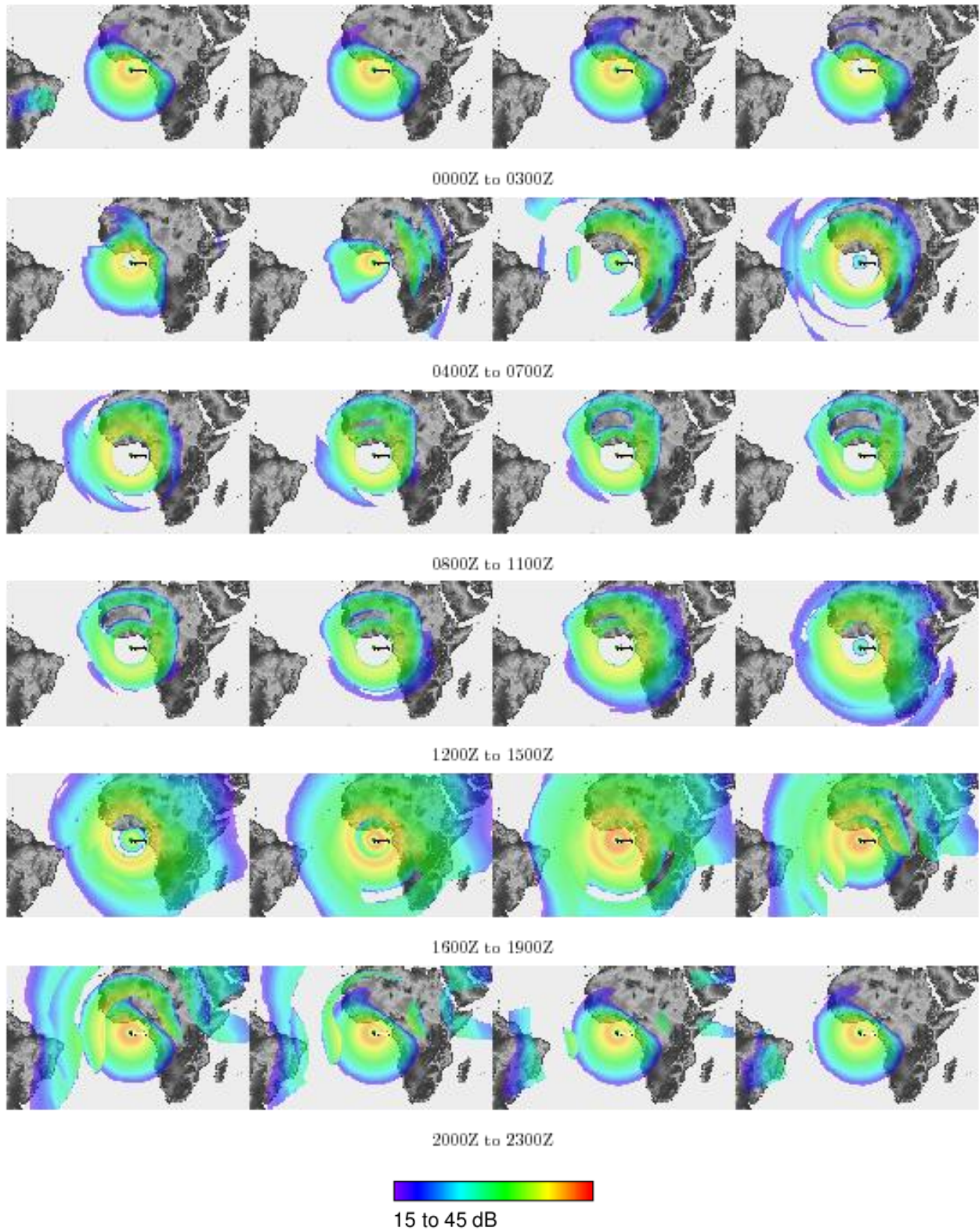

Figure D-4. Forecast availability for 3.0 and 13.0 MHz over a 24-hour period. This is a composite image where data from Figure D-3 and Figure D-4 are combined.



## HF Digital Radio Mondiale (DRM) Broadcast Summary Report

In Figure D-2, the low frequency signal (3.0 MHz) is seen to propagate well at night extending out hundreds of nautical miles. During the daylight hours, the signal is unusable. Figure D-3 shows the complete opposite. At night the high frequency signal (13.0 MHz) is either unusable or skips to distant locations. As the sun rises and ionizes the lower atmosphere the signal is once again available for users in the Gulf of Guinea. Note the skip zone that immediately surrounds the station. This will prove problematic as vessels within this zone may not be able to “hear” the broadcast; Recall that an HF signal is refracted off the atmosphere. It goes up, is bent, and then returns to earth. This zone of exclusion surrounding the station is a function of the ionospheric conditions and the frequency being transmitted. A ground wave signal may be present but it is possible that the vessel would be unable to receive either the skywave or the ground-wave.

From this brief discussion of HF propagation an apparent synergy arises between day and night. Figure D-4 shows the composite of the 3 and 13 MHz signals. Taken together this frequency diversity improves the signal availability to the Gulf of Guinea. More complex signal propagation modeling using this method is possible, but would take considerable time especially as the propagation conditions change from this idealized location. To simplify the modeling, a graphic that presents a snapshot for the entire day was developed. Figure D-5 shows the composite percent availability of the fictitious station. A user in the green shaded region would expect to receive either the 3.0 Hz or 13.0 MHz signal at least 90% of the day. Users in the locations shaded with yellow can expect a 90 – 75% availability. User in the red shaded area can expect a signal availability between 75-50% of the day.

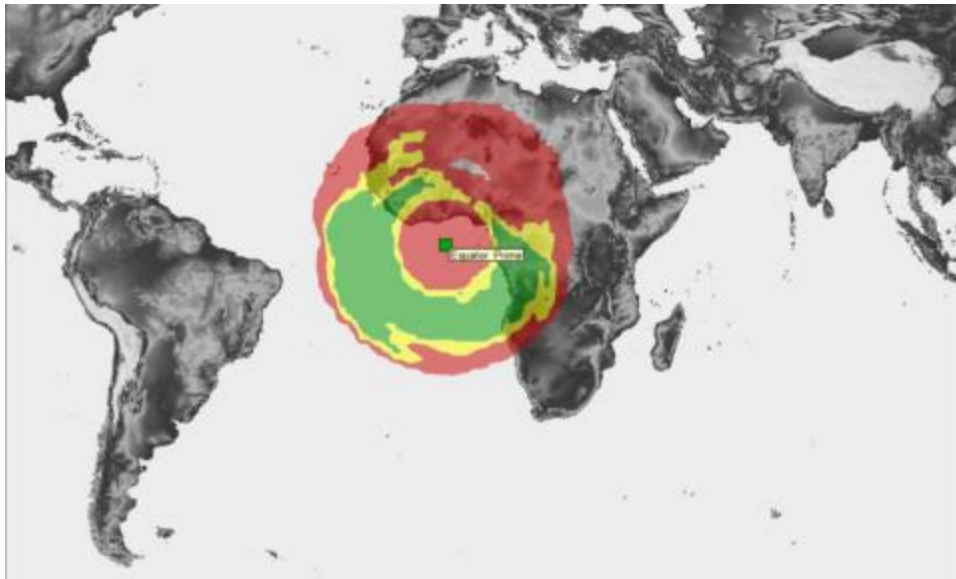

Figure D-5. Daily forecast of percent constructed by combining data from Figure D-4. Users in the green shaded area can expect a signal availability greater than 90%.



## APPENDIX E. TRANSMIT ANTENNA PATTERNS

This report mentions several different HF antennas, all of which are manufactured by TCI International, a subsidiary of SPX Corporation. Included are the TCI-550-4, TCI-530, and TCI-540. Each antenna is designed for a specific purpose:

- TCI-550-4: The 62-foot tower provides a moderate cost solution.
- TCI-530: The 133-foot tower supports an antenna designed for close-range communications.
- TCI-540: The quad 120-foot towers support a high gain omnidirectional antenna.

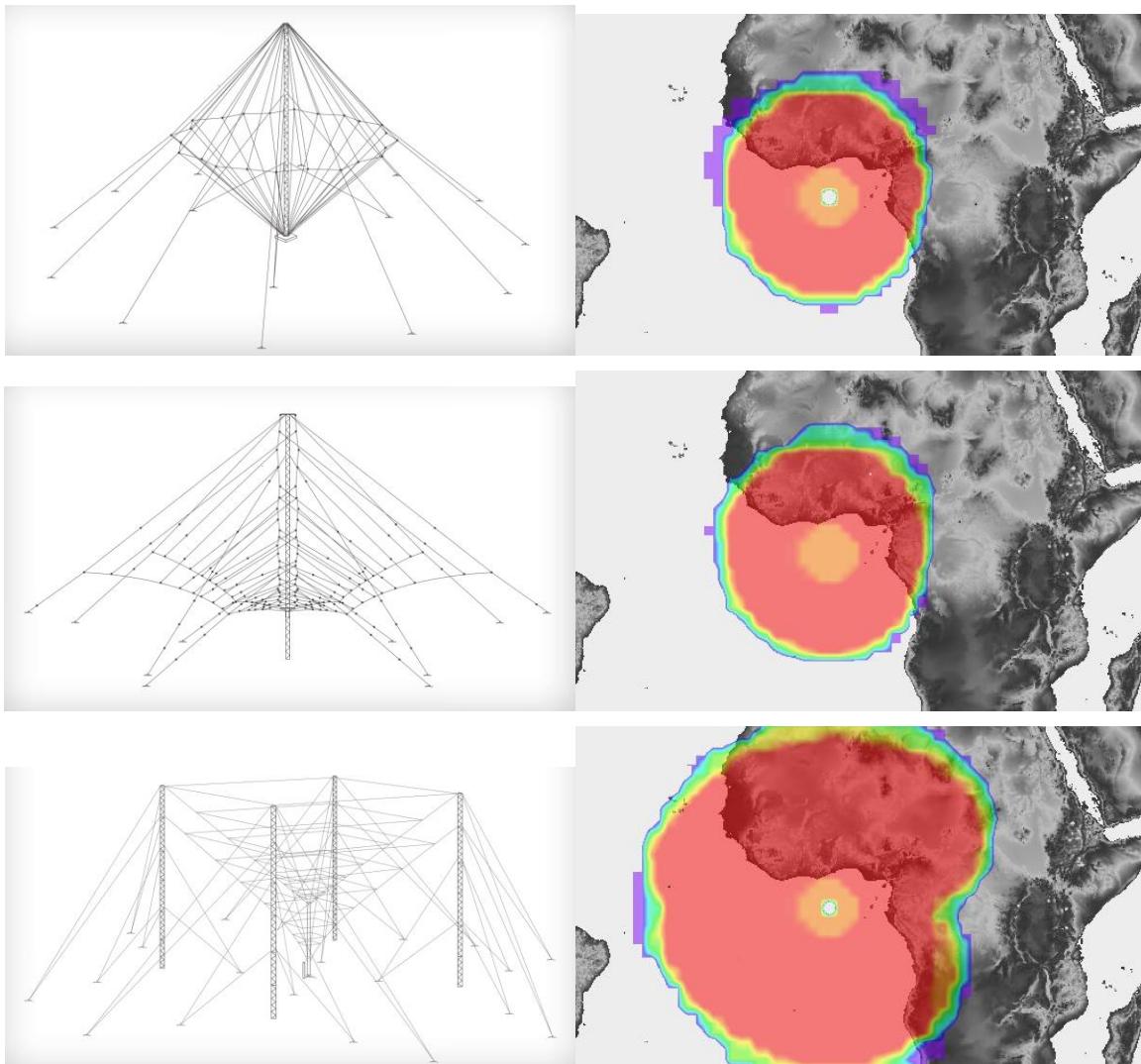

Figure E-1. Representative antennas and radiation patterns TCI-530 (middle), TCI-540 (bottom), TCI-550 (top).

**(This page intentionally left blank.)**



### APPENDIX F. ARTICLE – AMATEUR RADIO DRM RECEPTION

# U.S. Coast Guard Testing DRM Journaline for Maritime Safety Broadcast

---

SWL3409PL — DECEMBER 4, 2016

*Blog Editor Note: This feature and more will be available in the new International Shortwave Broadcast Guide Winter 2016-2017 e-Book that will be released in the next few days on Amazon. Watch this site for an announcement of availability.*

Story by Larry Van Horn, N5FPW

Most shortwave radio enthusiasts have heard of digital broadcast mode Digital Radio Mondiale (DRM). DRM is a set of standards designed by a European consortium, and most commonly used for digital audio broadcasting and it is the only digital HF broadcasting mode authorized by the International Telecommunications Union (ITU) and Federal Communications Commission (FCC) here in the United States.



DRM transmissions sporadically appear on the various broadcast bands and offer the listener high quality broadcast audio if the signal is strong enough for reception. There are also text stream, and other data sub-channels that can be imbedded in a DRM transmission streams. For all the usual reasons, DRM has never caught on in North America. Among other problems, changing market forces had killed off most or all of the DRM-ready transmitting sites capable of a 12 dB signal to noise ratio to DRM capable receivers.

Recently while tuning outside the international shortwave broadcast bands, a Mojave Desert, California, DX'er nicknamed Token, came across some DRM transmissions on 5200 and 8000 kHz. The signals he monitored were using the Orthogonal Frequency Division Multiplex (OFDM) in a tight waveform fitting the 10-kHz broadcast channel.

When he started decoding the DRM transmission what he found was not a voice audio broadcast, but instead a data sub-channel which identified itself as “USCG Journaline.” Journaline is a trademark of Fraunhofer IIS, in Germany. It’s a hierarchical data mode, using a “Journaline Markup Language” based on





## HF Digital Radio Mondiale (DRM) Broadcast Summary Report

---

XML (eXtensible Markup Language). This is sent in one or more DRM data channels. It also works in DAB (Digital Audio Broadcasting). It is currently being used by several broadcasters, including BBC and Deutsche Welle, for “multicast” information such as news stories and weather maps. While not interactive, it does give the user menus of data “objects” available for viewing. It somewhat resembles a very streamlined and compacted one-way version of what web browsers do.

Some quick research, by Token and Hugh Stegman, *The Spectrum Monitor e-zine Utility Planet* columnist, turned up that indeed, the U.S. Coast Guard was responsible for these DRM Journaline broadcasts.



COMMSTA Kodiak (Courtesy of USCG 17th District Blog)

Subsequent research by the pair found the following U.S. government website entry: “The United States Coast Guard Research and Development Center has a requirement to procure, install and provide technical support for Digital Radio Mondiale (DRM) with High Frequency (HF) for testing in New London, CT and Kodiak AK.”

“Later amendments specify that the DRM equipment must work with existing (and nonlinear) HF transmitters by Rockwell Collins. The transmitting antenna must be the existing TCI 530. The receive antenna must be “suitable for installation on a medium-sized vessel (100-250 ft.)” Another source, Doug Irwin in Radiomagonline, has the following information: “The USCG is very interested in testing the propagation characteristics of using DRM with High Frequency as a means to broadcast digital data for its ongoing project in the Northwest Passage. If successful, the USCG will investigate using the system to enhance existing means of distributing digital maritime safety information in the far north of the U.S.”

The Arctic region in recent years has become navigable in summer, and for the first time the fabled “Northwest Passage” actually exists as a shipping route. International groups have created new world navigation areas (NAVAREAs) for this region. The USCG has a number of testing programs regarding



## HF Digital Radio Mondiale (DRM) Broadcast Summary Report

---

safety on this new frontier. Among other issues, these latitudes are a bit far north for geostationary satellites stationed in the “Clarke Belt.” That’s one of the reasons why we keep seeing interest in HF. The USCG became interested after a contractor called RFMondial reported the success of a similar system used by the German Navy. This one, according to the same source, “explored how to use encrypted data transmission for maritime broadcasting of information and entertainment to ships at sea.”

Utility DX Forum member Brendan Wahl WA7HL, a former U.S. Coast Guard radioman, dug further into the story by contacting the project office directly and passes along the following information regarding this new DRM service that the US Coast Guard is testing.

“The Next Generation Arctic Navigational Safety Information System (ANSIS) project is an ongoing U.S. Coast Guard (USCG) Research and Development Center (RDC) project that is attempting to meet the challenge of disseminating Maritime Safety Information in the Arctic.

“I had a conference call on November 21, 2016, with the good folks at R&D to go over what can be offered by the monitoring community and me to their experiment. They are quite interested in reports that are as detailed as possible. I am running the DReaM software here and using DRMPlot to produce graphs of my logs, and they like those graphs very much!”

Officials associated with the project told Brendan, “For a variety of reasons we ended up with DRM over HF. It is where the data rate would allow transmission of detailed weather, ice edge, and notice to mariner’s information, as well as electronic chart updates. A one year field test is being conducted in Alaska. We completed installation during the week of October 23, 2016. We have been working with RFMondial and Fraunhofer. We are transmitting (at around 800 watts) from Kodiak and our receive equipment is in Cordova (shore side and aboard the buoy tender). We have 10 authorized frequencies to use between 2.45 and 29.9 MHz. But have reduced them to the six lowest frequencies.

“Initial research indicates that lower frequencies are best, so we came up with a schedule for these transmissions. The test will go for one year, so we may change this schedule at some point to maximize reception.”

Brendan further asked about the antenna system and they confirmed that they are using a TCI 530 antenna (omnidirectional and NVIS).

He also addressed to the Coast Guard the frequencies being used for the test since two of them are in broadcast bands and he relayed his concerns about directly adjacent and on-frequency interference from much higher powered broadcasters.



## HF Digital Radio Mondiale (DRM) Broadcast Summary Report

---

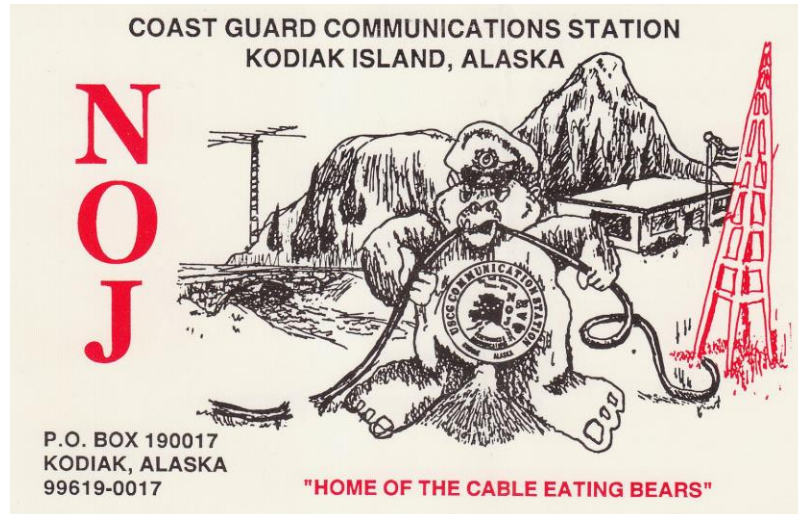

The project office said that the frequencies may or may not change, as it was apparently difficult to arrange what they did get allocated. Currently they are 2450, 5200, 6850, 8000, 9900, and 12100 kilohertz (kHz) with three more inactive higher frequencies in reserve. The transmission site is located in Kodiak, Alaska, (Coast Guard call sign NOJ) and it is the only transmitter site for this experiment at present. The precise location of the station is at 57.778455N, 152.526588W.

Brendan also received a current schedule of dates/times/frequencies for these broadcasts for the next year and we have included that information below (schedule is not included in this Appendix). The broadcasts are on 24 hours a day and last until the next frequency change in the schedule. Reception reports may be emailed directly to the R&D Center in New London at the following email address: [drminfo@uscg.mil](mailto:drminfo@uscg.mil). If anyone has any questions, you can contact Brendan via the UDXF group and feel free to contact him there and he will contact members of the group conducting the test to get answers you may have.

We appreciate *The Spectrum Monitor*, *Utility Planet* columnist Hugh Stegman, Token in the Mojave, the UDXF newsgroup, and Brendan Wahl, WA7HL, located in Bellingham, Washington, for their assistance in preparing this article.



## APPENDIX G. ADDITIONAL UNDERWAY DATA

This Appendix provides additional sampling of underway data. The data in this Appendix adds to the sampling of data provided in section 5.1.2. This was done for easier reading in the main part of the report. It includes the additional data received for the following frequencies:

- 5200 kHz.
- 6850 kHz.
- 8000 kHz.

As with section 5.1.2, the figures occur in groups of two or three. With the forecast data in one graphic and the SNR in the other two (one for the USCGC HEALY and the other for the USCGC MAPLE).



# HF Digital Radio Mondiale (DRM) Broadcast Summary Report

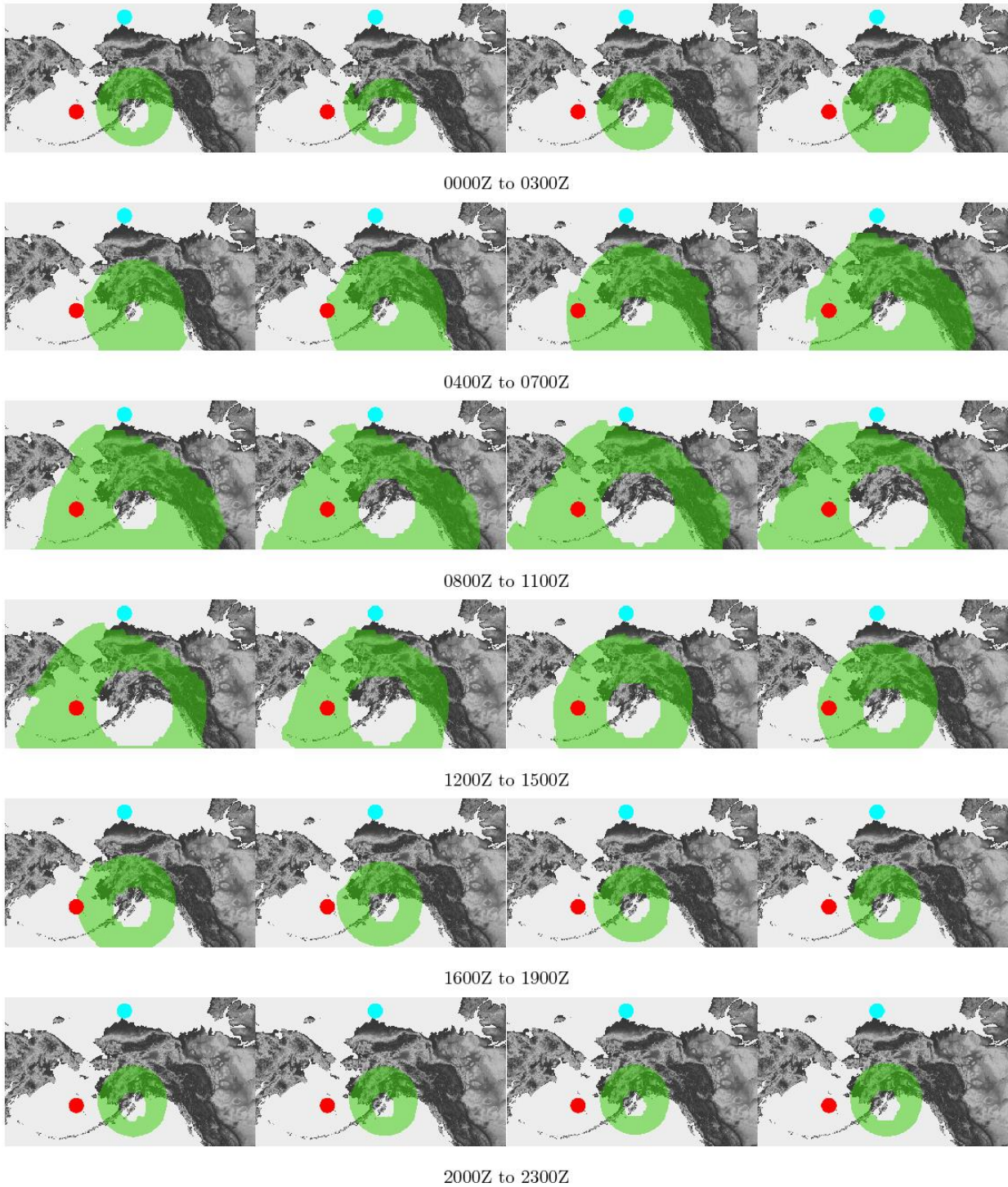

Figure G-1. Jul 25, 2017 forecast of 5200 kHz (green) with USCGC HEALY (red) and MAPLE (cyan).



# HF Digital Radio Mondiale (DRM) Broadcast Summary Report

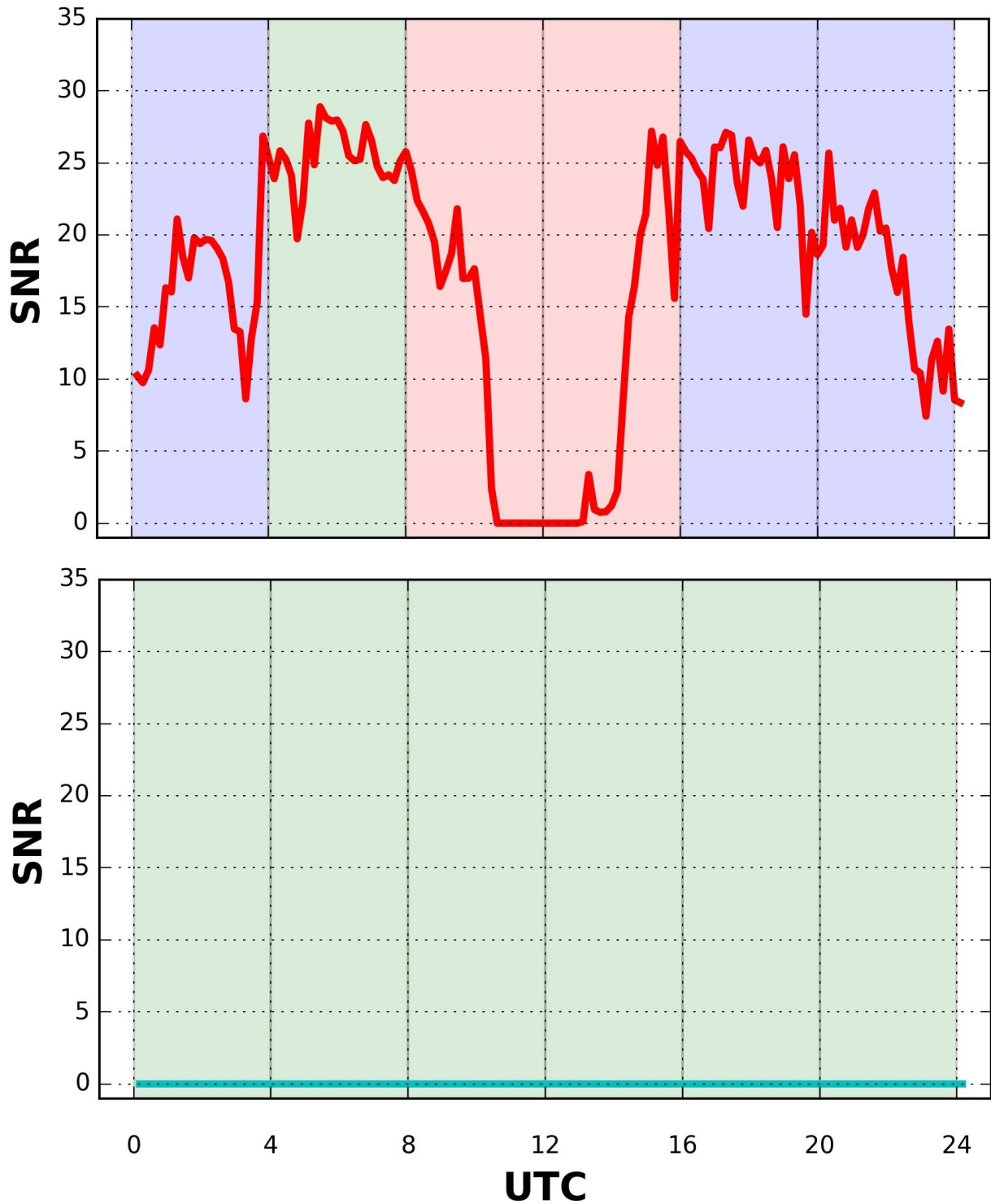

Figure G-2. Jul 25, 2017 SNR as recorded on USC GC HEALY (red) and MAPLE (cyan).



# HF Digital Radio Mondiale (DRM) Broadcast Summary Report

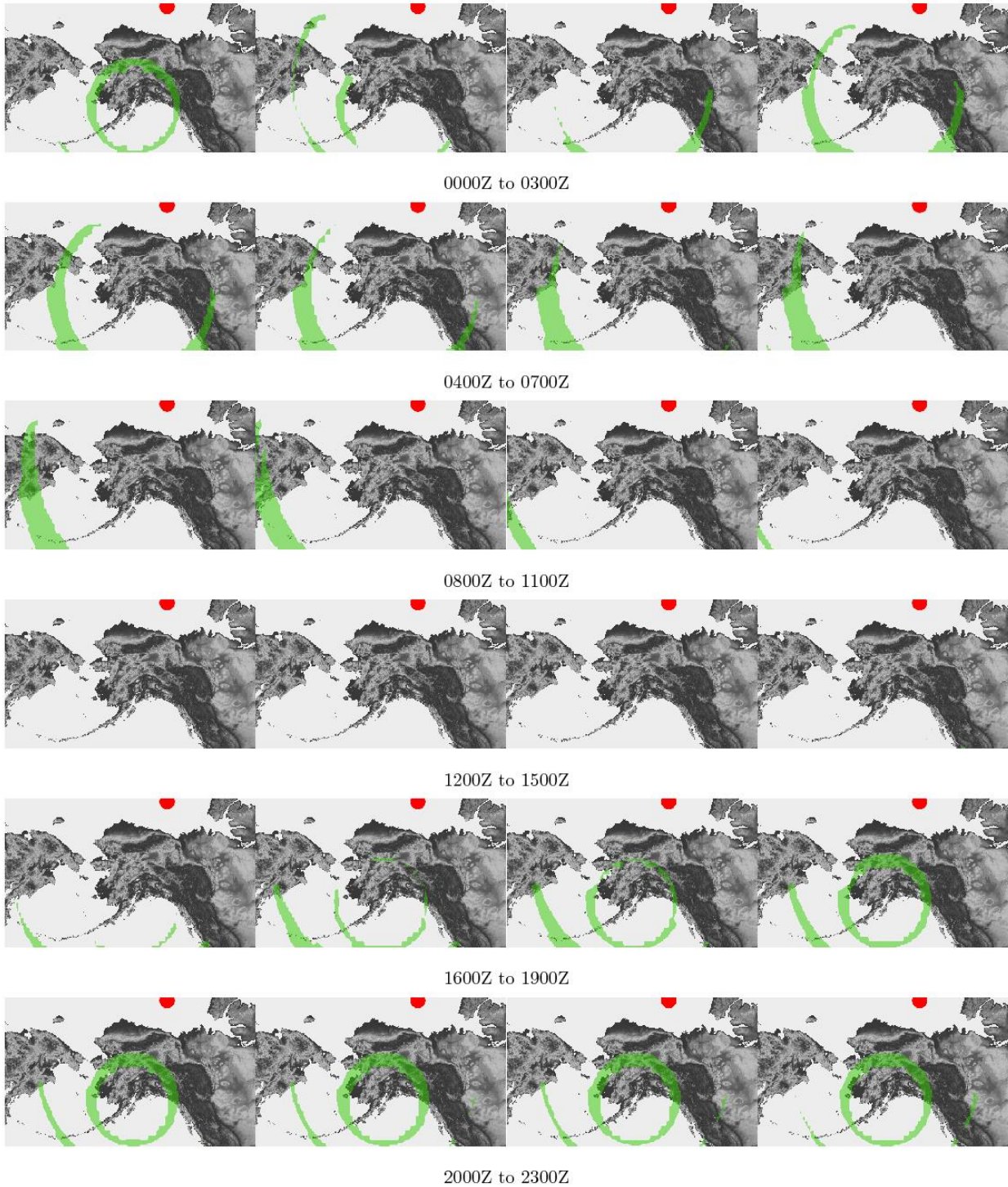

Figure G-3. Aug 01, 2017 forecast of 8000 kHz (green) with USCGC HEALY (red).



# HF Digital Radio Mondiale (DRM) Broadcast Summary Report

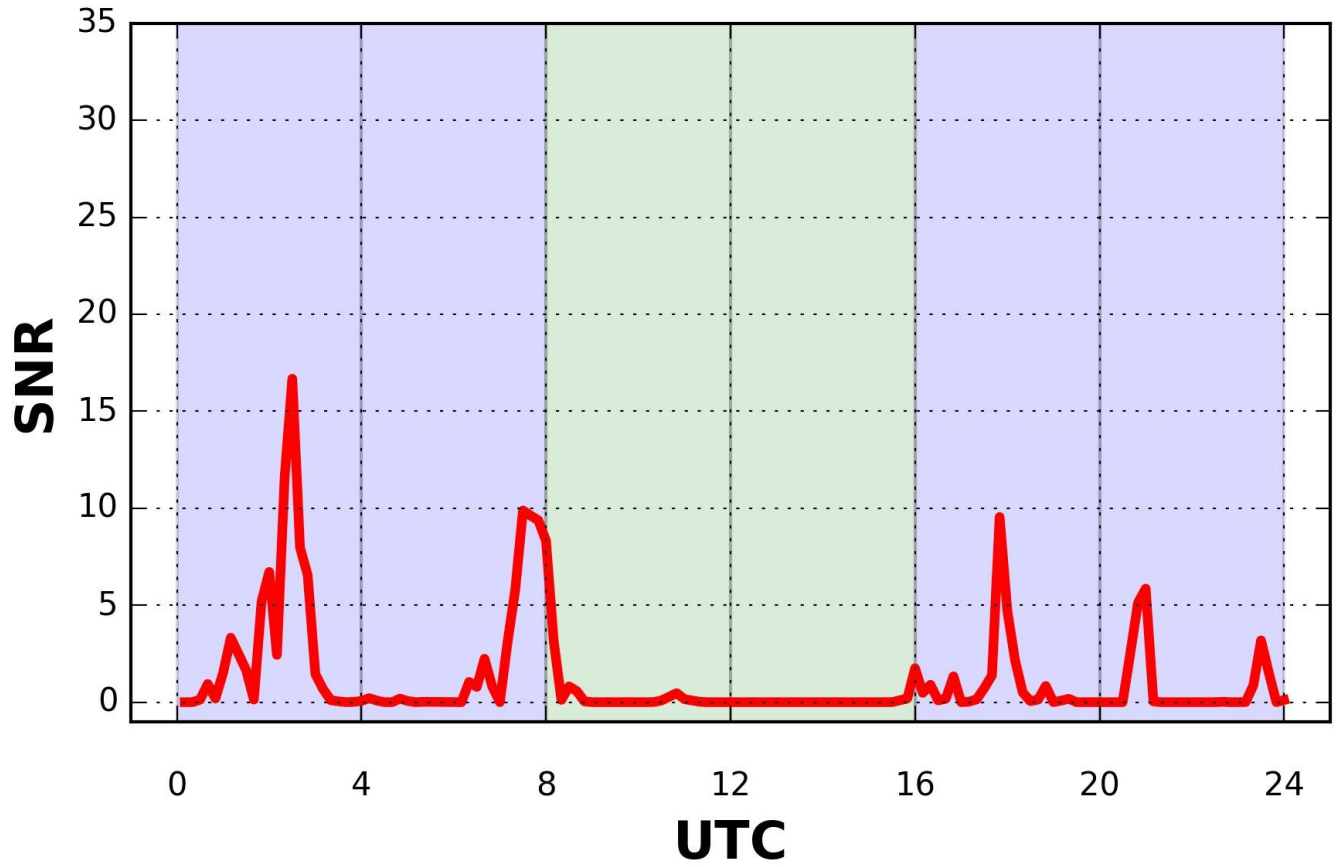

Figure G-4. Aug 01, 2017 SNR as recorded on USCGC HEALY.





# HF Digital Radio Mondiale (DRM) Broadcast Summary Report

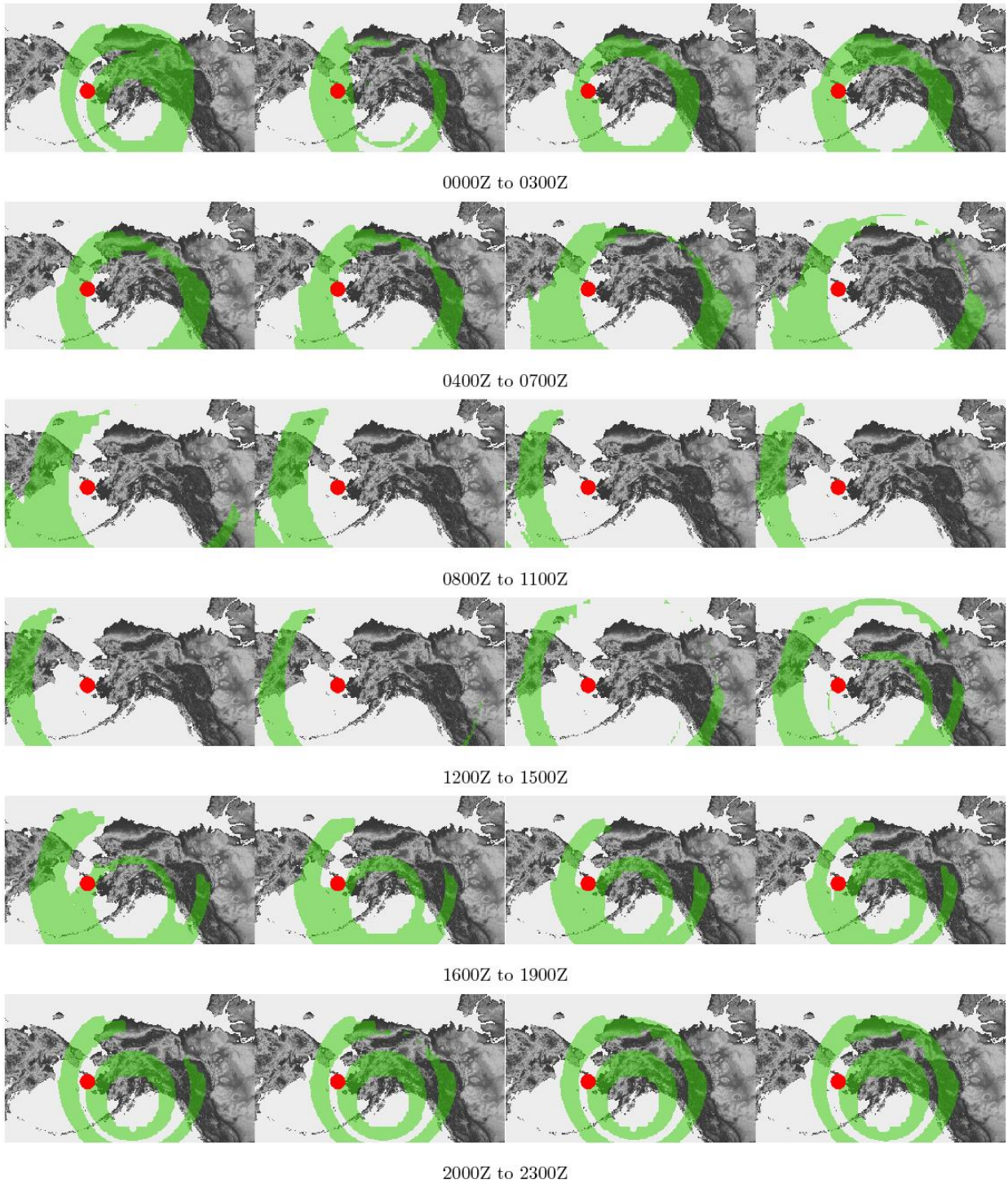

Figure G-5. Aug 08, 2017 forecast of 8000 kHz (green) with USCGC HEALY (red).



# HF Digital Radio Mondiale (DRM) Broadcast Summary Report

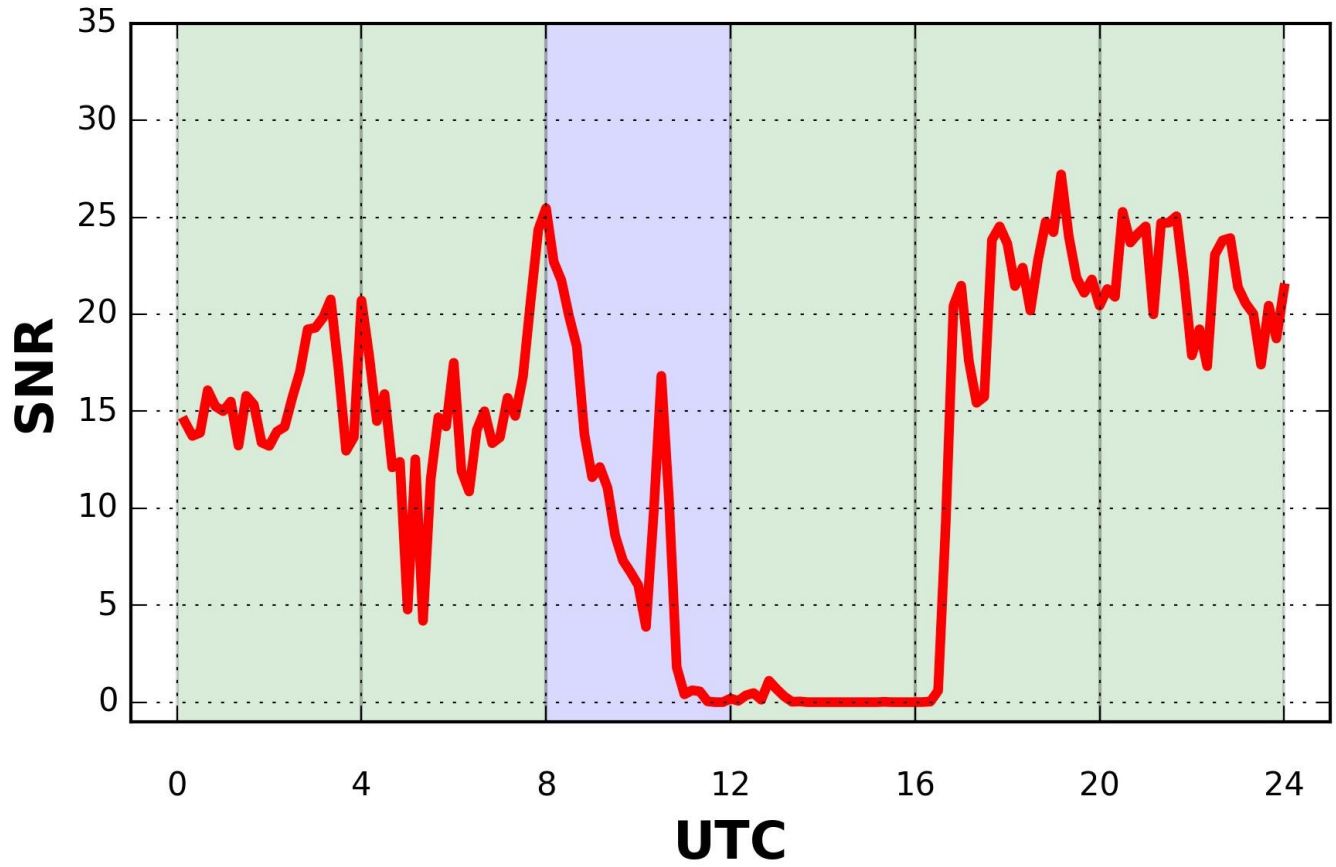

Figure G-6. Aug 08, 2017 SNR as recorded on USCGC HEALY.



# HF Digital Radio Mondiale (DRM) Broadcast Summary Report

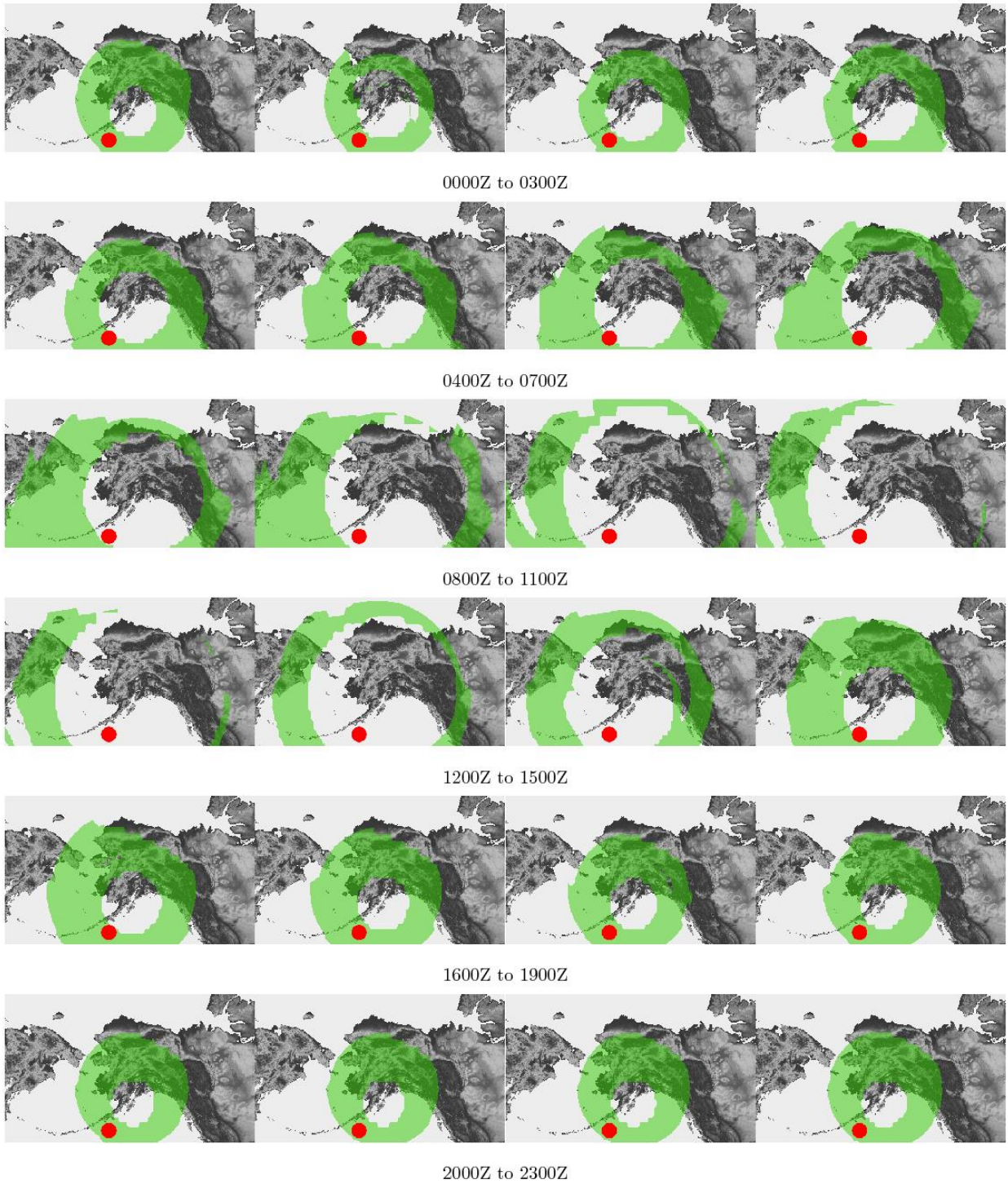

Figure G-7. Aug 10, 2017 forecast of 6850 kHz (green) with USCGC HEALY (red).



# HF Digital Radio Mondiale (DRM) Broadcast Summary Report

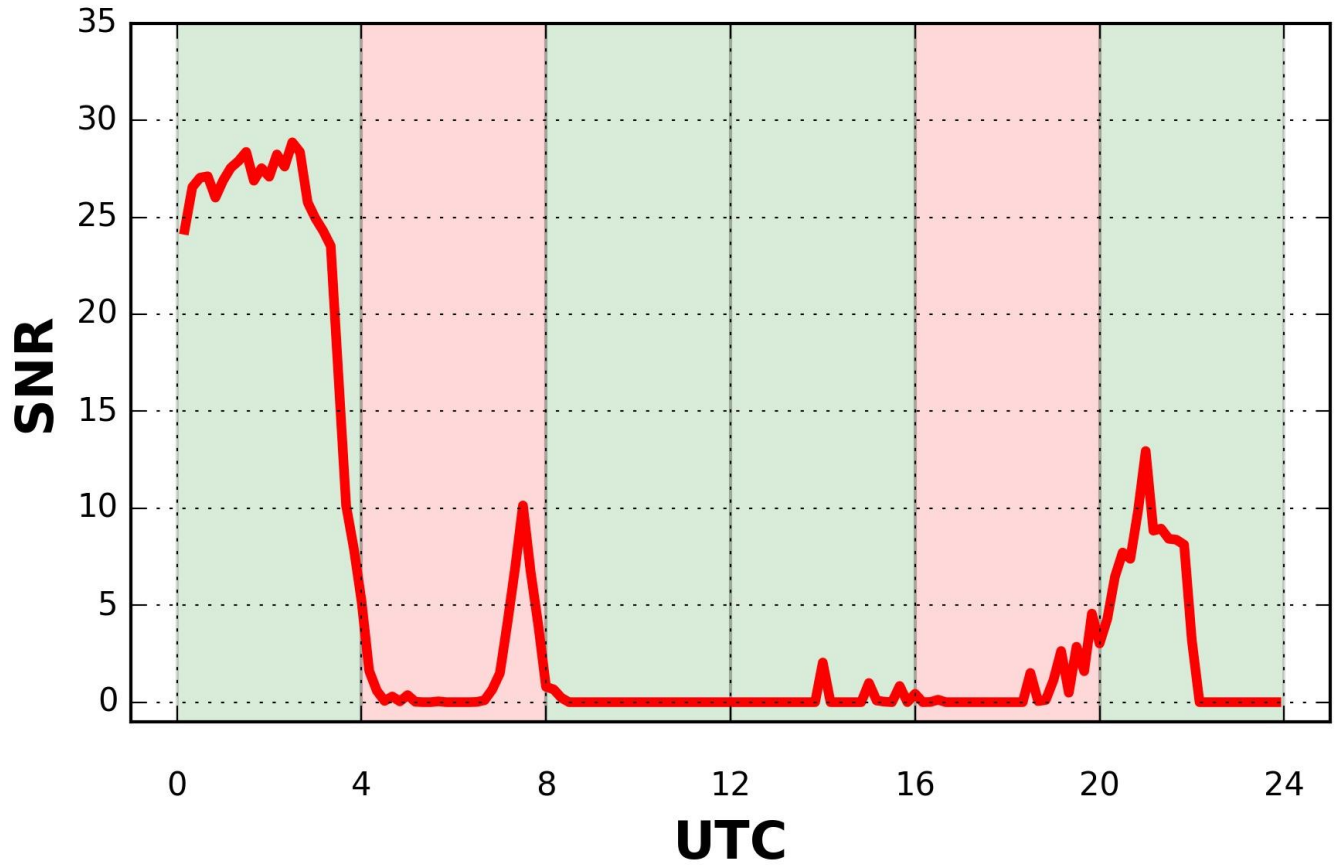

Figure G-8. Aug 10, 2017 SNR as recorded on USCGC HEALY.



## APPENDIX H. ADDITIONAL BACKGROUND

The International Maritime Organization (IMO), a United Nations specialized agency, has two current initiatives related to this project. The first initiative is the modernization of the Global Maritime Distress and Safety System (GMDSS), and the second is the e-Navigation<sup>21</sup>, which aims to integrate, exchange, present, and analyze marine safety information through electronic means (eMSI) [10] . Additional detail about these initiatives can be found in *RDC Review/Status of IMO MSI Systems* [11] . The Navigational Telex (NAVTEX) [12] system is a component of GMDSS that is employed to broadcast Maritime Safety Information (MSI) to ships at sea. It operates on 490 kHz, 518 kHz, and 424 kHz. It has a data rate of 100 bps with a 300 Hz channel. The USCG has worked with IMO and the International Telecommunications Union (ITU), another United Nations agency, to propose a next-generation NAVTEX system called Navigational Data (NAVDAT). NAVDAT is a digital broadcasting system working in the 500 kHz band based upon the Digital Radio Mondiale™ (DRM) broadcast standard [13] .

The RDC performed a preliminary investigation into the two DRM options for providing eMSI and navigation safety information (NSI) over an extended range using fewer transmit sites than required for standard AIS. They were DRM using Medium Frequency (MF) transmissions (NAVDAT) and DRM using High Frequency (HF) transmissions [12] . Of these two options, the HF DRM option appeared to be the most feasible to test and implement due to coverage range predictions [15] and the existing USCG HF infrastructure in Alaska. MF transmissions have less coverage and limited availability of USCG transmitters in AK.

### H.1 DRM Lab and Field Testing

The test plan consisted of both a lab test and a field test. Additional details can be found in the “*The Long Range Transmissions of AIS Safety Information*” [16] . The RDC’s initial concern with using the USCG’s existing URG III HF Transmitter, was that the URG III was non-linear, which is not ideal for DRM’s linear transmissions. Rockwell Collins, the manufacturer of the URG III, indicated that the transmitter has an operational bandwidth of at least 50 kHz. This bandwidth is sufficient for the modulated DRM input, which has a 10 KHz bandwidth, as long as there is a linear region within this band. A lab test was needed to determine its suitability to transmit DRM.

The URG III system consists of the Rockwell Collins Control (RCC) software, RT-2200 exciter and PA-2224. The PA-2224 needs the frequency information from the RT-2200 to pull in the low pass filters, thus the RDC fabricated a new power amplifier (PA) control cable. The role of the RCC software was to monitor the system and set desired frequencies. In the lab test, the USCG HF Transmitter URG III and PA-2224 4-KW power amplifier were connected to the Digital Radio Mondiale (DRM) Modulator. Figure H.1 shows the lab test equipment set-up.

The new PA control cable connected the exciter to the power amplifier. The keyline (signal switch to activate the transmitter) was broken out so the DRM can control the keyline through a relay. The 4-KW system was transmitting into a dummy load. The receive antenna was a circle and placed around the dummy load. The DRM was connected to RF input to the PA-2224. The forward power, current, temperature and other PA outputs were closely monitored while the DRM input level was varied to the power amplifier.

---

<sup>21</sup> <http://www.iala-aism.org/meetings-events/committees/enav/>



# HF Digital Radio Mondiale (DRM) Broadcast Summary Report

After several iterations, input levels were determined (around 800W) that would provide 3-4 KW output power. The system transmitted for six hours while the PA temperature was measured. The temperature stayed within a normal operating range (30 degrees Celsius). The DRM data were modulated, transmitted, received, and decoded successfully during the lab test.

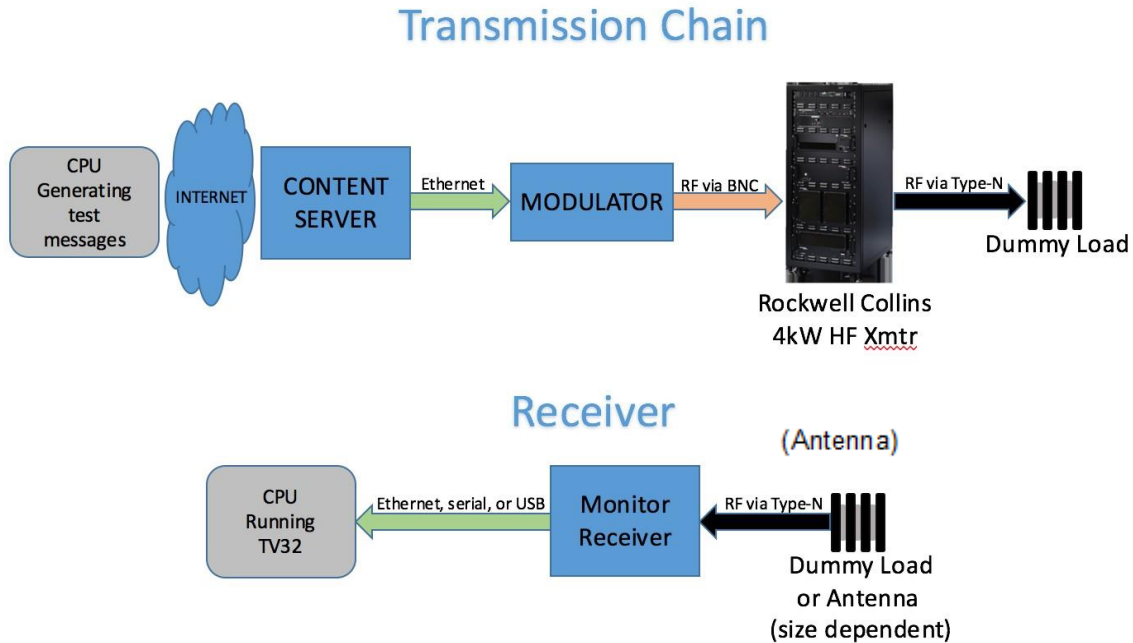

Figure H-1. Lab test equipment set-up.

The results of the lab testing guided specific equipment configurations for the field testing. Other studies were reviewed [17]. Kodiak was selected as the transmit site, Cordova was selected as the shore site, and USCGC SYCAMORE (Buoy Tender) as the vessel receive site. Expectation was that ground wave coverage would reach Cordova and provide a good shore baseline reception. Due to a variety of reasons (e.g., Kodiak antenna in a low area with hills surrounding it, frequencies used, antenna position on Sycamore), reception at Cordova was not good. This led the project team to look for vessels of opportunity to move the receive equipment to areas with expected reception coverage. The USCGC HEALY was selected due to its science-oriented mission and transit along the Alaskan coast and up to the north slope of Alaska. The USCGC MAPLE was selected to possibly support its travels along the Northwest Passage.

The results of the field testing were designed to enable the final report (this report) to address system performance: data rate, message transfer success rate, the suitability of the various frequencies, any weather and seasonal effects on system performance and frequency selection, noise performance, and coverage range. During the test period, feedback from the users was also solicited to get their impressions of the data received and its usefulness to support operations.



# HF Digital Radio Mondiale (DRM) Broadcast Summary Report

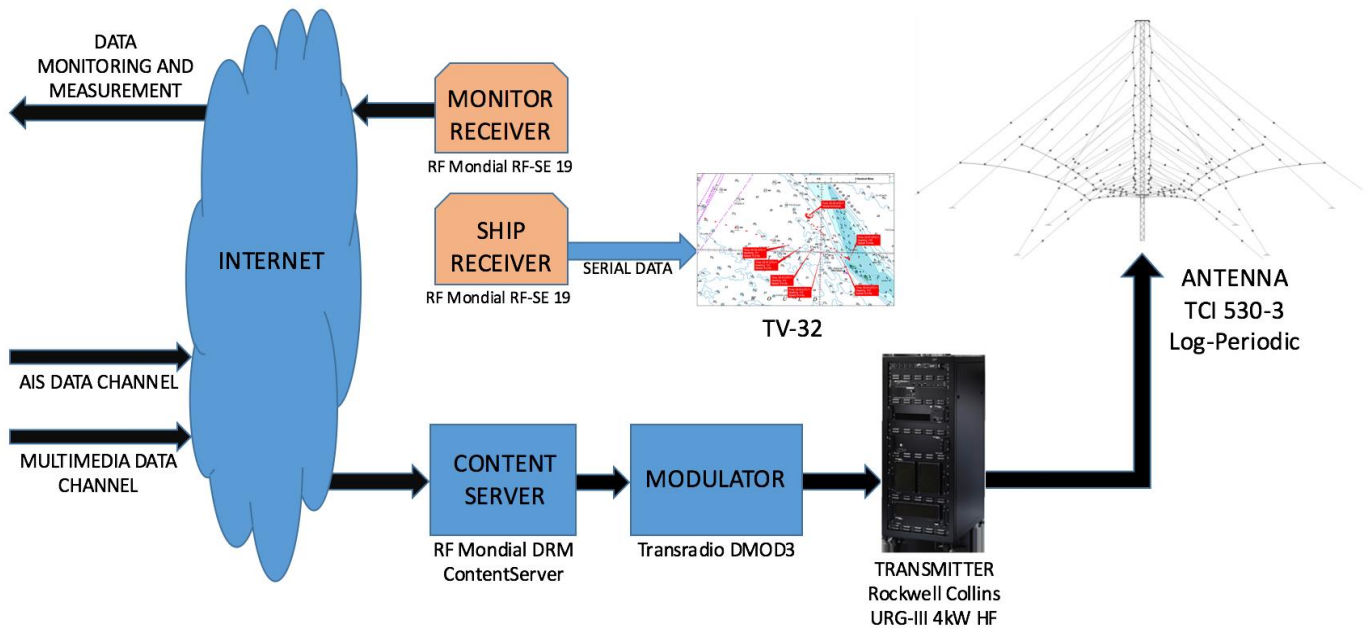

Figure H-2. Field test equipment set-up.

Figure H-2 represents the block diagram showing the overall system architecture as it was installed for the Alaska field testing [2]. As mentioned earlier, this setup combines the existing USCG infrastructure with Commercial-Off-The-Shelf (COTS) DRM equipment supplied by RFmondial. The RDC used the existing Communications Station (COMMSTA) Kodiak, AK as the transmission site and installed the receivers at a remote location in Cordova, AK. Later on, the RDC relocated the receivers to the USCGC HEALY and MAPLE for more experiments.

Initially, the user uploads the information to the content server through a variety of methods such as Transmission Control Protocol/Internet Protocol (TCP/IP) serial streams for asynchronous or synchronous binary data, File Transfer Protocol (FTP), Rich Site Summary (RSS)/Atom feeds, and Hypertext Transfer Protocol (HTTP) mirroring. Then, the content server generates Multiplex Distribution Interface (MDI) packets, which contain several DRM transmission parameters and packetized user content. DRM Modulator uses MDI packets to generate the transmitter’s RF signal. On the physical layer, the MDI stream is shared with any device with User Datagram Protocol (UDP/IP) [18].



**(This page intentionally left blank.)**

